

GW-7553 (Modbus RTU master)
example for SIMATIC STEP 7

Example 1: Reads DO module data from GW-7553(Modbus FC01).

Example 2: Reads DI module data from GW-7553(Modbus FC02).

Example 3: Reads AO module data from GW-7553(Modbus FC03).

Example 4: Reads AI module data from GW-7553(Modbus FC04).

Example 5: Writes DO module data from GW-7553(Modbus FC05,15).

Example 6: Writes AO module data from GW-7553(Modbus FC06,16).

Example 1: PLC reads DO module data from GW-7553.
(Modbus FC01)

Read a Modbus RTU DO module (PROFIBUS Slave & Modbus RTU/Master)

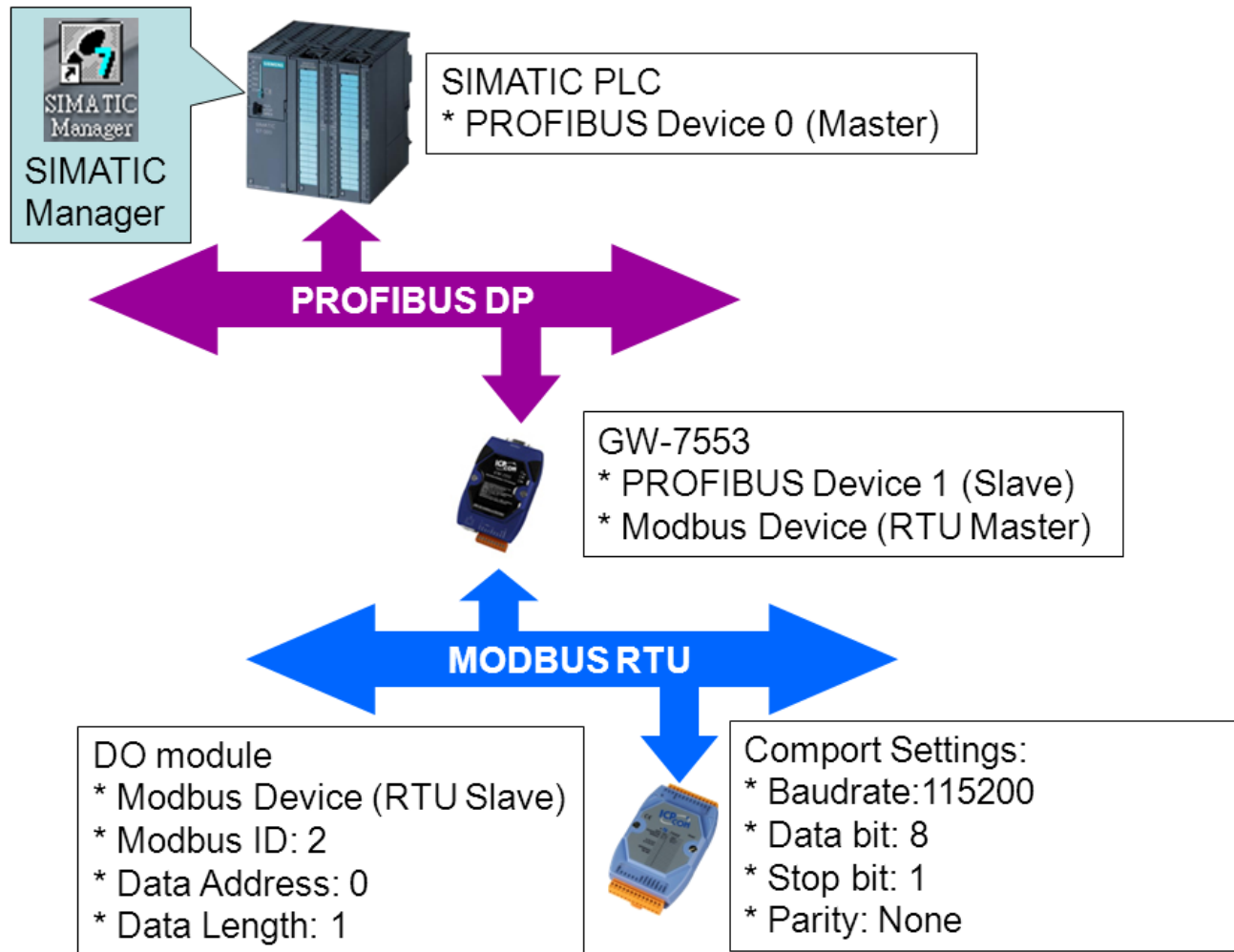

SIMATIC STEP7 Configuration:

Step 1: Setup the GW-7553 module

1. Select GW-7553 module

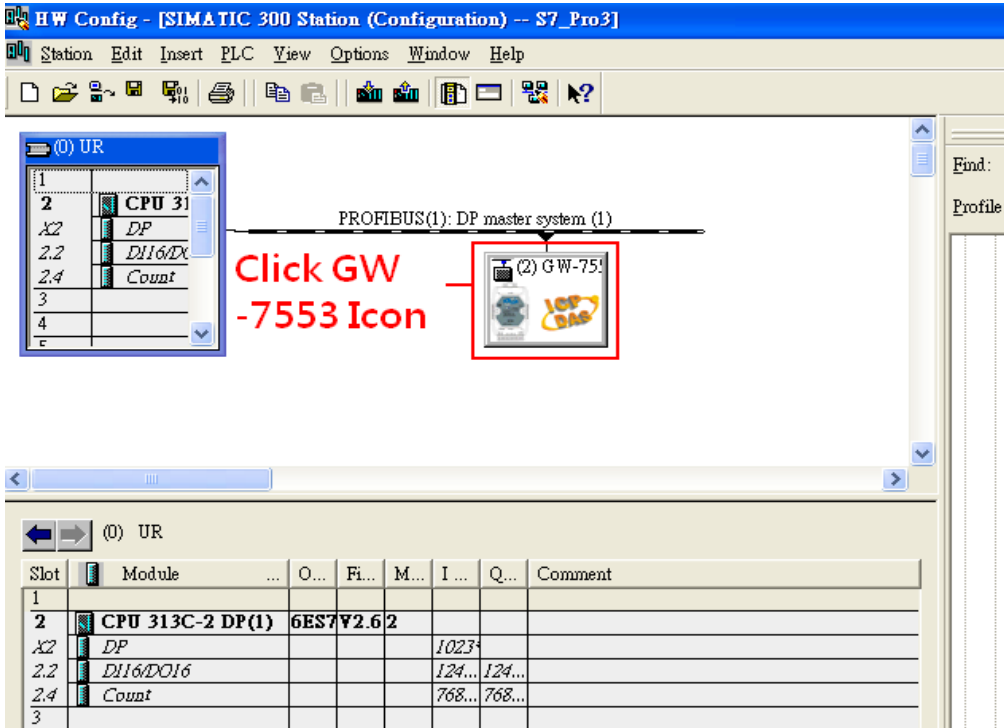

2. Add a System setting module

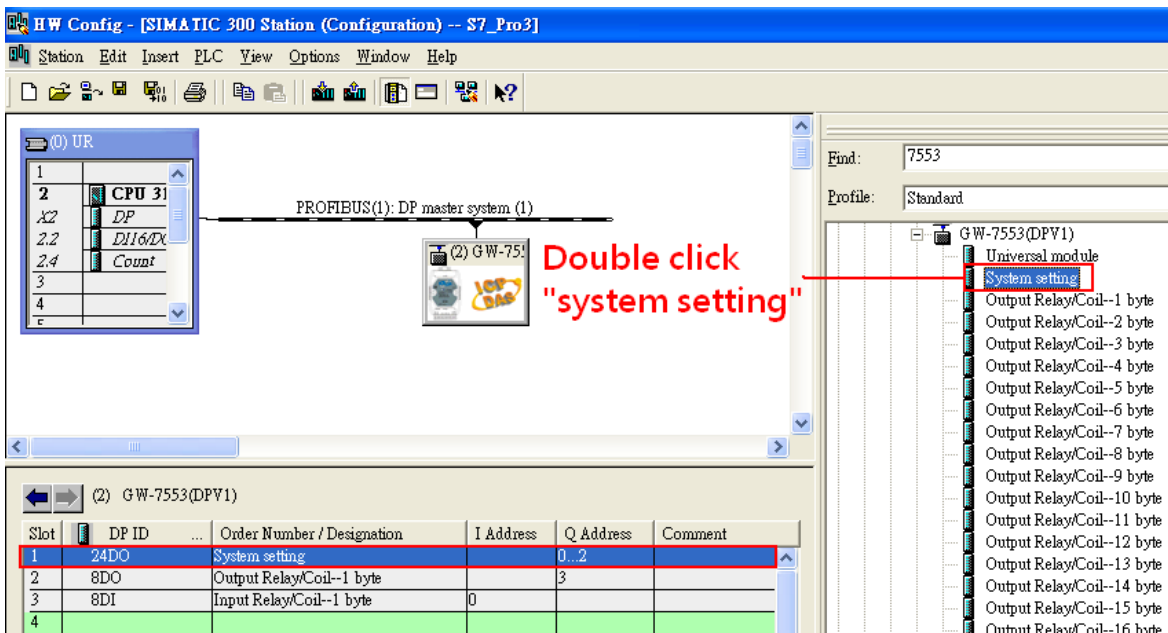

3. Add "Output Relay/Coil – 1 byte" and "Input Relay/Coil – 1 byte"

Double click "Output Relay/Coil - 1 byte"

Slot	DP ID	...	Order Number / Designation	I Address	Q Address	Comment
1	24DO		System setting		0..2	
2	8DO		Output Relay/Coil-1 byte		3	
3	8DI		Input Relay/Coil-1 byte	0		
4						

Double click "Input Relay/Coil - 1 byte"

Slot	DP ID	...	Order Number / Designation	I Address	Q Address	Comment
1	24DO		System setting		0..2	
2	8DO		Output Relay/Coil-1 byte		3	
3	8DI		Input Relay/Coil-1 byte	0		
4						

Step 2: Setup the parameters of the GW-7553

1. Double click GW-7553 icon
2. Select "Parameter Assignment"

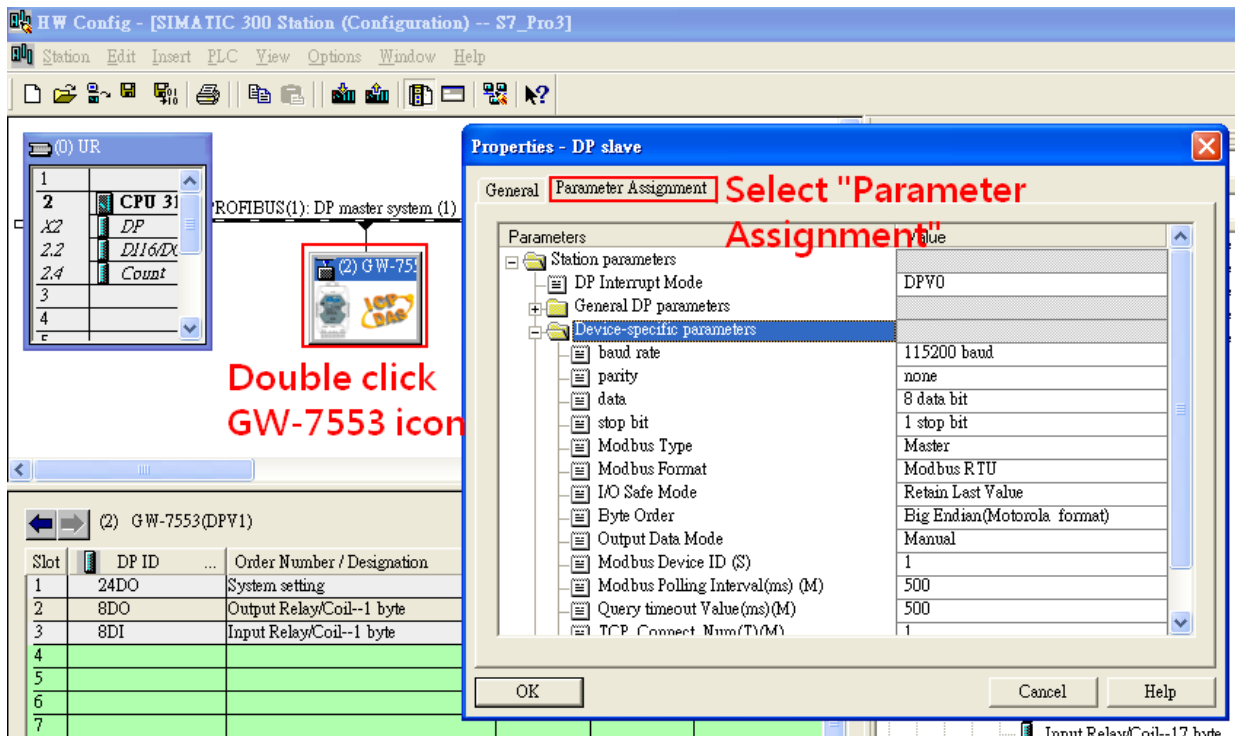

3. Set common parameters of the GW-7553

Common parameters →

Baud rate: 115200; Parity: none; Data: 8 data bit; Stop bit: 1 stop bit; **Modbus type: Master**
Modbus Format: Modbus RTU; Byte Order: Big Endian

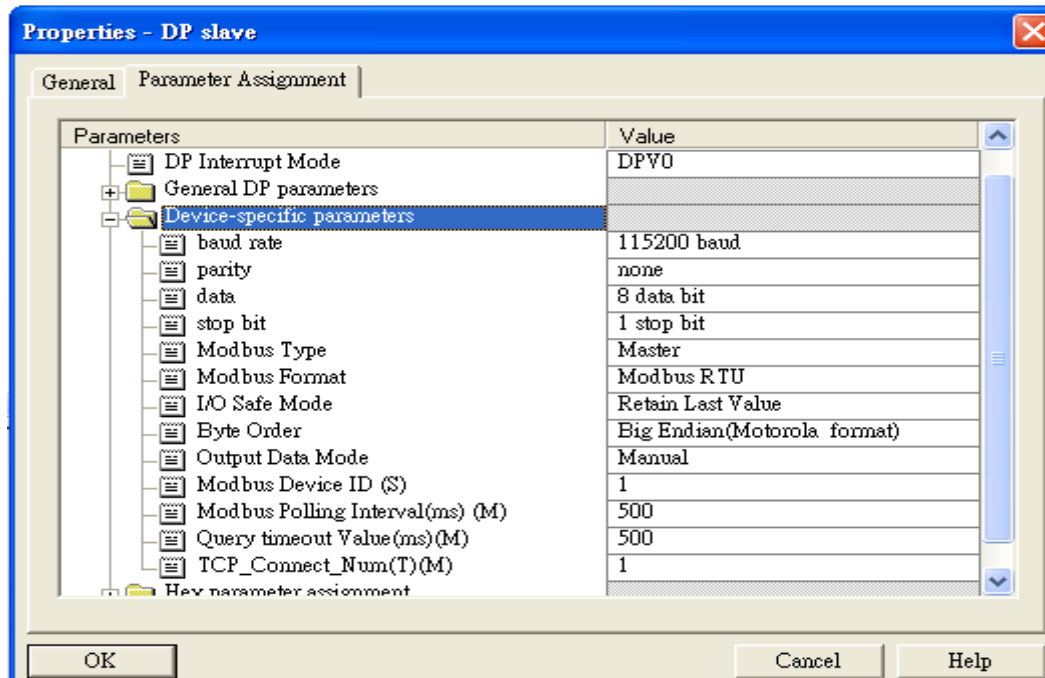

4. Set module parameters of the GW-7553

(1) Double click "Output Relay/Coil – 1 byte" module

(2) Select "Parameter Assignment"

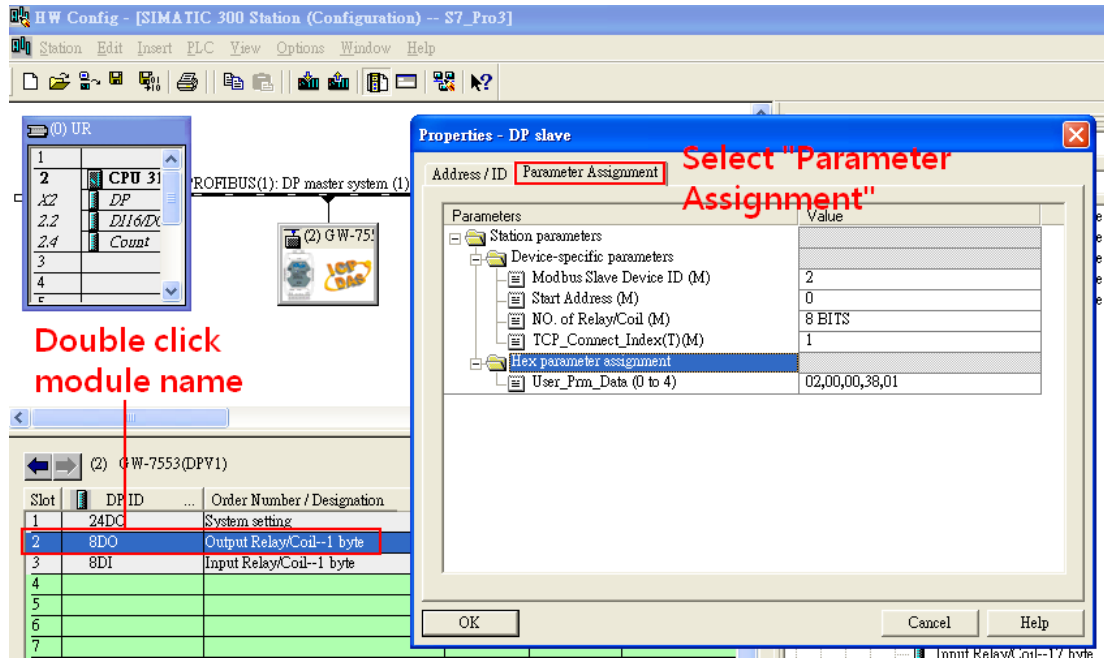

5. Setup "Output Relay/Coil – 1 byte" module parameter

Module parameters →

Modbus Slave Device ID: 2; Slave Address: 0 (Protocol address (base 0))

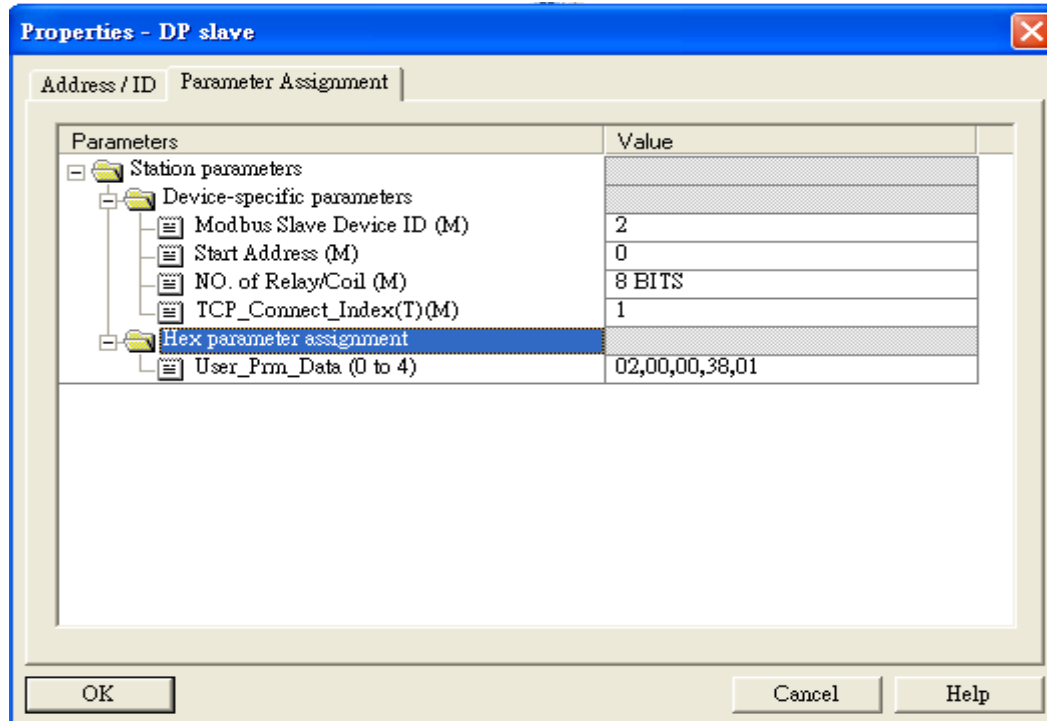

6. Set module parameters of the GW-7553

(1) Double click "Input Relay/Coil – 1 byte" module

(2) Select "Parameter Assignment"

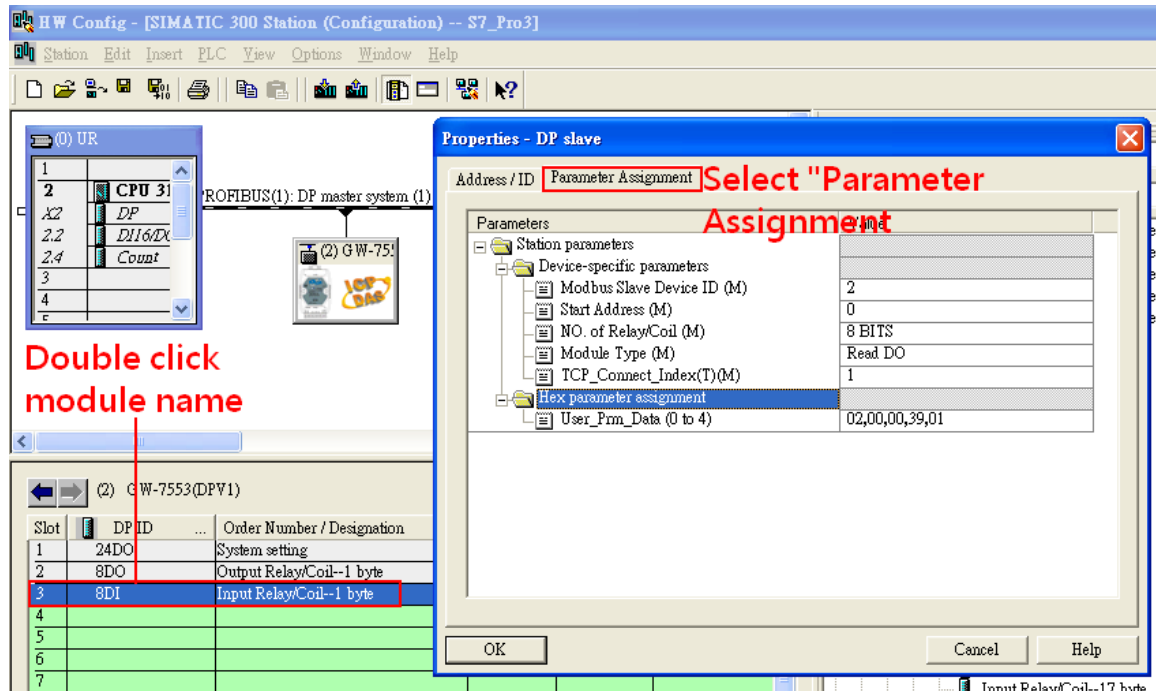

7. Setup "Input Relay/Coil – 1 byte" module parameter

Module parameters →

Modbus Slave Device ID: 2; Slave Address: 0 (Protocol address (base 0))

Module Type: Read DO, click ok.

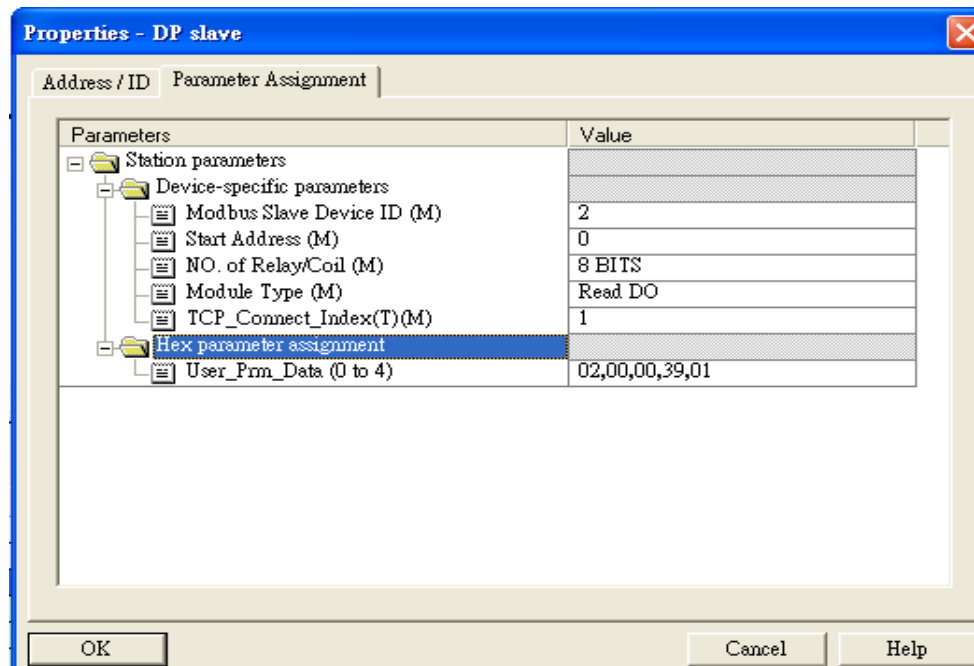

Step 3: Download the HW settings into SIMATIC PLC

1. Save and Compile

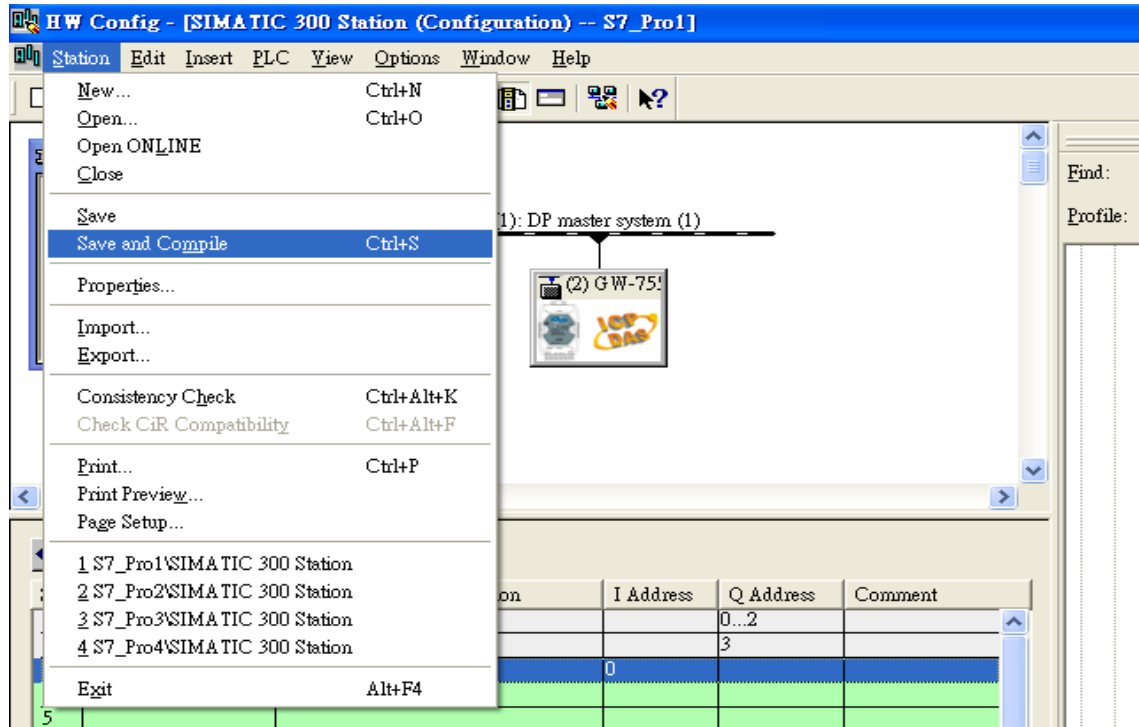

2. HW settings into SIMATIC PLC

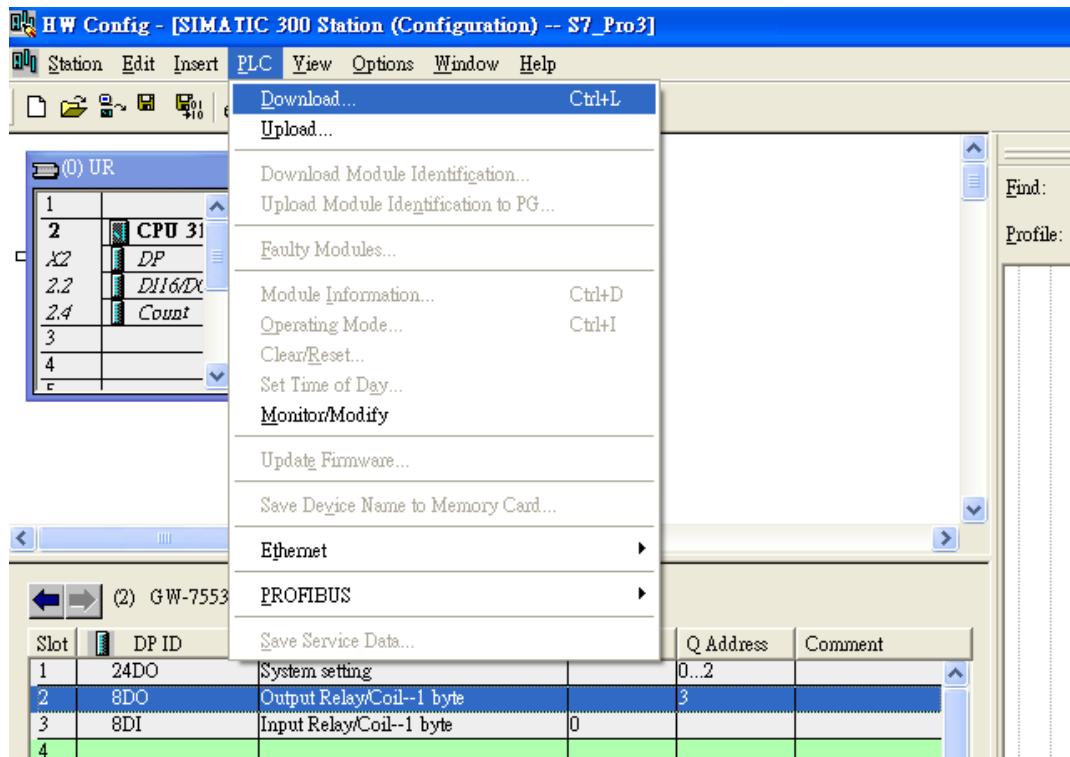

Step 4: Insert a new Organization Block (OB1,OB82,OB86)

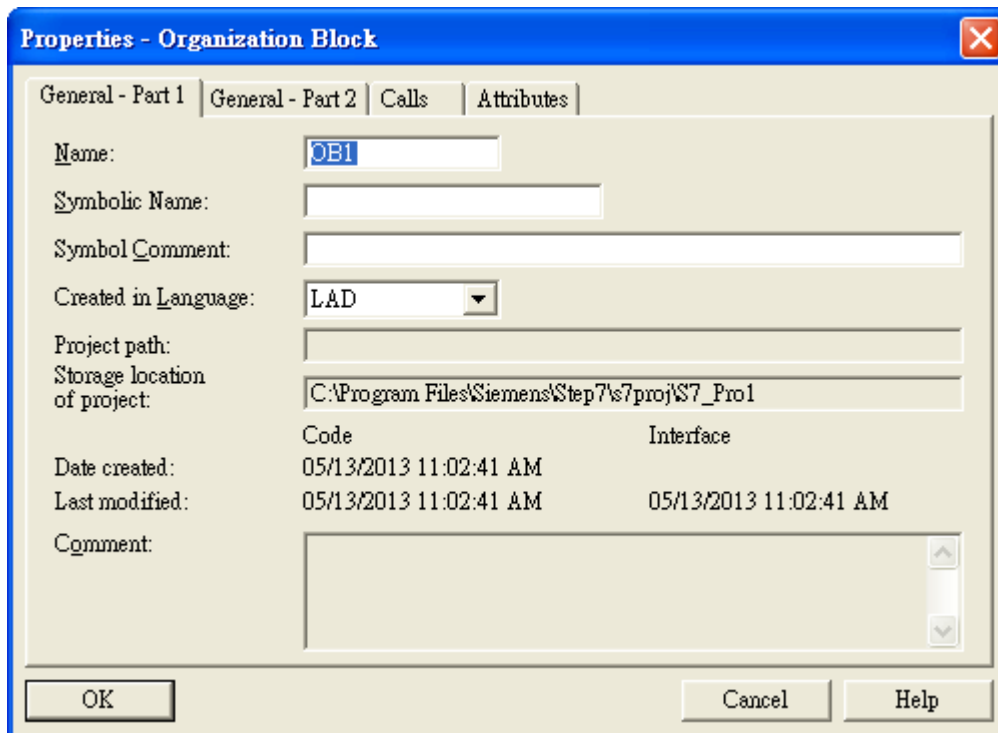
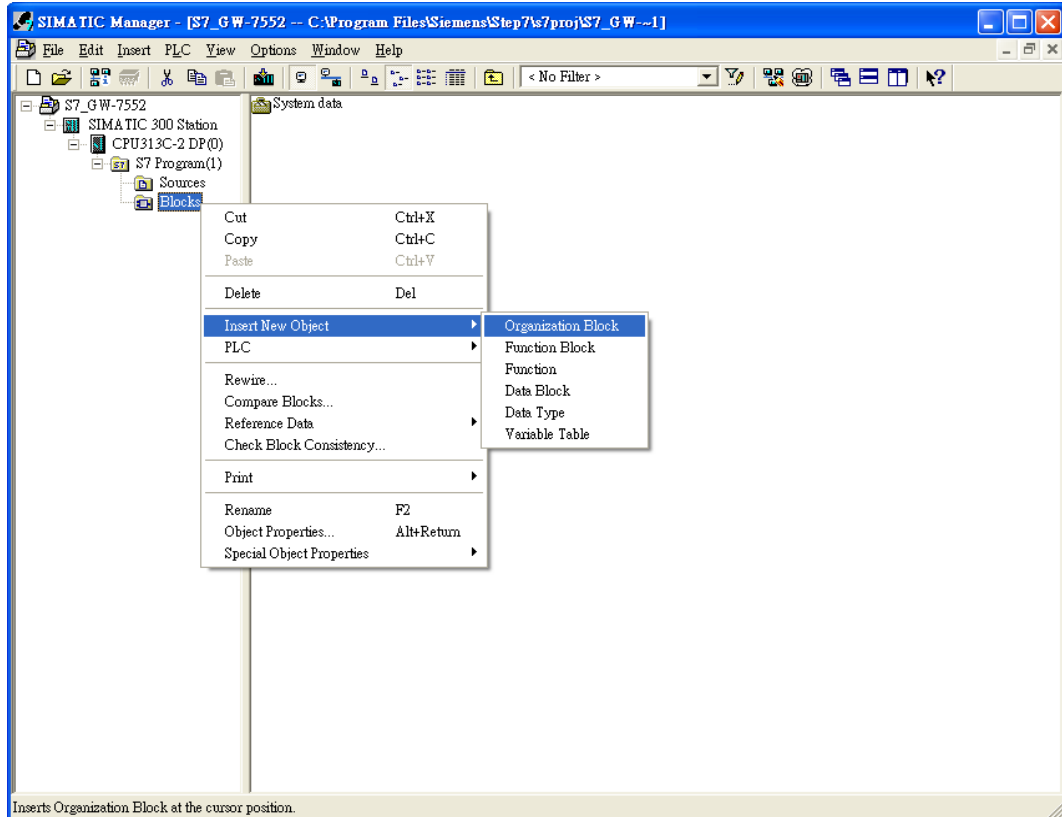

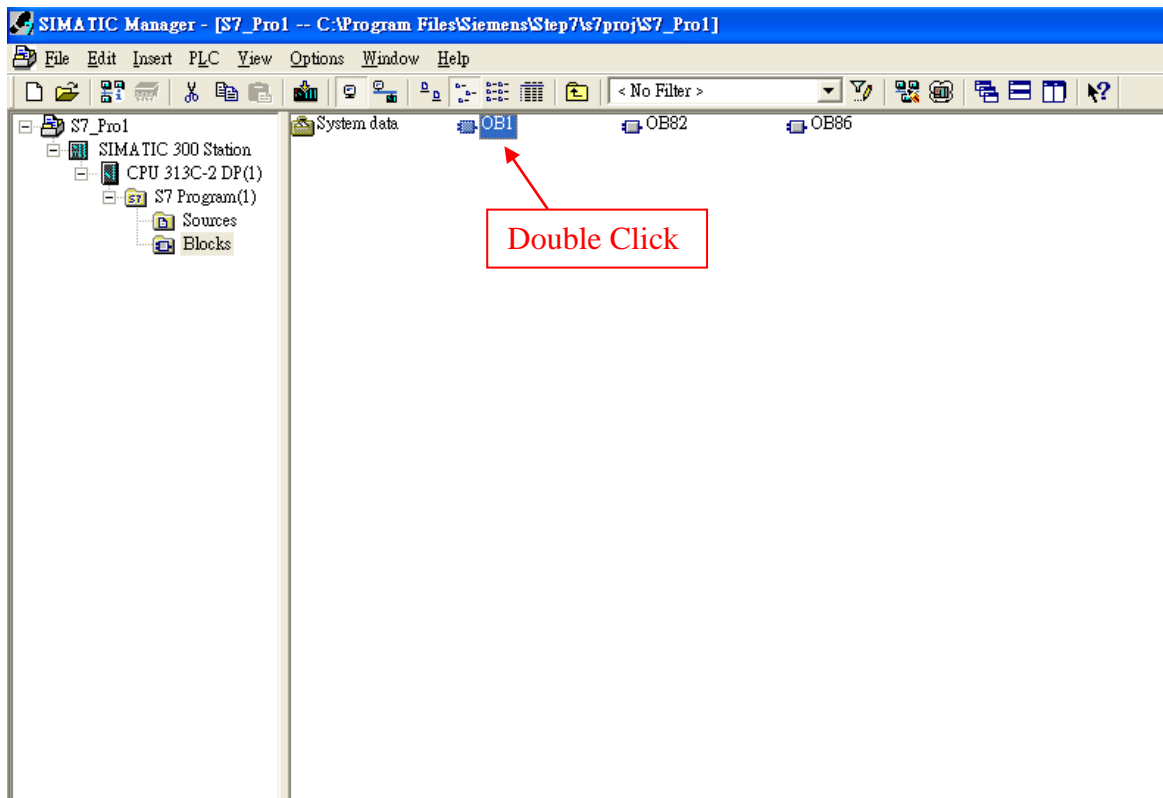

Step 5: Edit OB1

Variables used in the example LD Program:

	Name	Data Type	Address	Comment
	END	Bool	20.0	
	INIT	Bool	20.1	
	Tri	Int	22.0	
	DIValue	Byte	24.0	

OB1 : "Main Program Sweep (Cycle)"

PROFIBUS Slave
Modbus Master

Network 1 : Reset Counter(C1)

Reset Counter (C1)

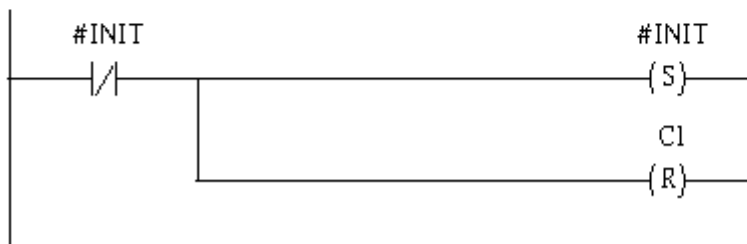

Network 2: Title:

Comment:

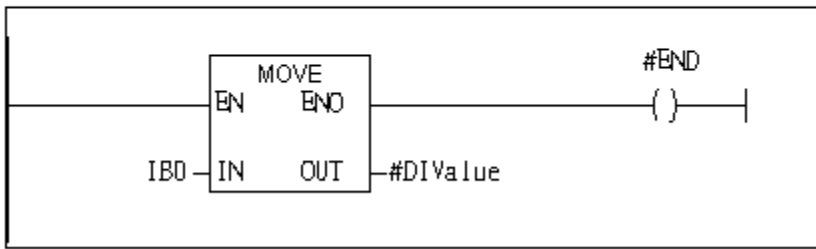

Network 3: QB0 add "1" then PLC will send QW3 out.

1 byte DO

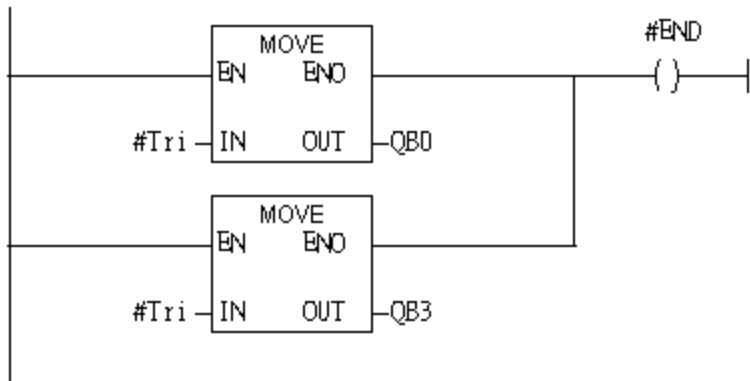

Network 4: Timer T1 & T2

Using T2 trigger T1

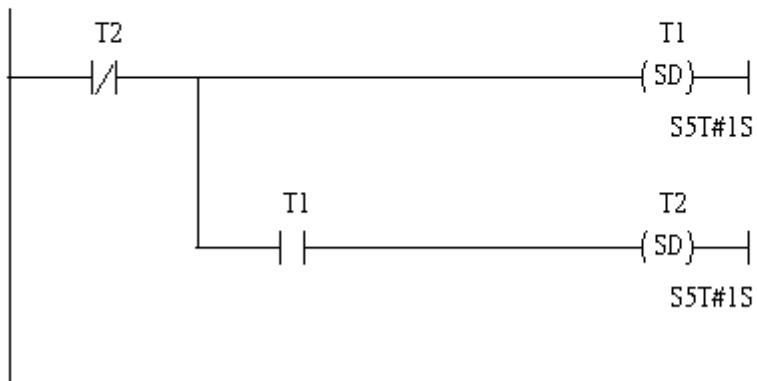

Network 5 : Counter C1

If counter(C1) add "1" and Tri will add "1" ,too.

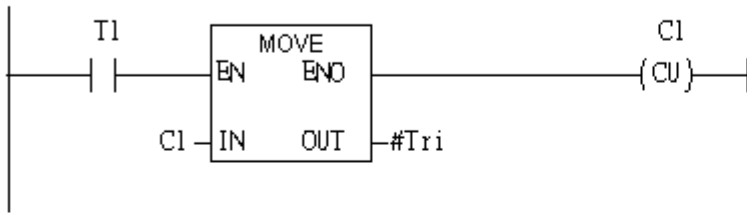

Network 6 : Compare Tri & 256

If Tri is equal to 256,C1 will reset

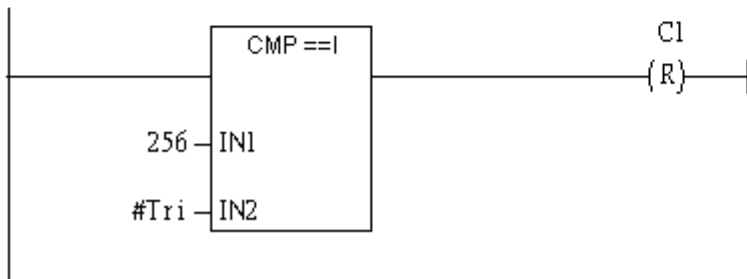

Step 6: Download the settings into SIMATIC PLC

The screenshot shows the SIMATIC Manager interface. The 'Download' menu is open, showing options like 'Select Online CPU...', 'Establish Connection to Configured CPU', 'CPU Messages...', 'Display Force Values', 'Monitor/Modify Variables', 'Module Information...', 'Operating Mode...', 'Clear/Reset...', and 'Set Time of Day...'. Below the menu, a table displays data for 'Environment\Interface\TEMP':

Name	Data Type	Address	Comment
OBI_MAX...	Int	10.0	Maximum cycle time of OBI (milliseconds)
OBI_DAT...	Date_...	12.0	Date and time OBI started
END	Bool	20.0	
INIT	Bool	20.1	

Below the table, the 'Network 1 : Reset Counter(C1)' is visible, showing a reset coil '(R)' for counter 'C1' connected to a normally open contact labeled '#INIT'.

Step 7: Make sure the RUN LED of the GW-7553 is on and the switch of the GW-7553 is at Normal mode.



Now the setting procedure has been finished and the user can read the data to the Modbus DO module at address IB0.

Network 2: Title:

Comment:

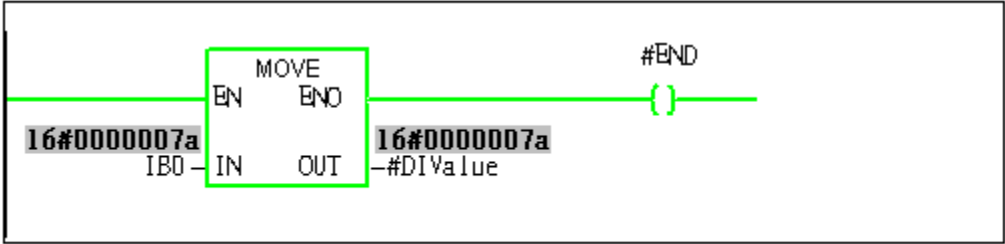

Example 2: PLC reads DI module data from GW-7553. (Modbus FC02)

Read a Modbus RTU DI module (PROFIBUS Slave & Modbus RTU/Master)

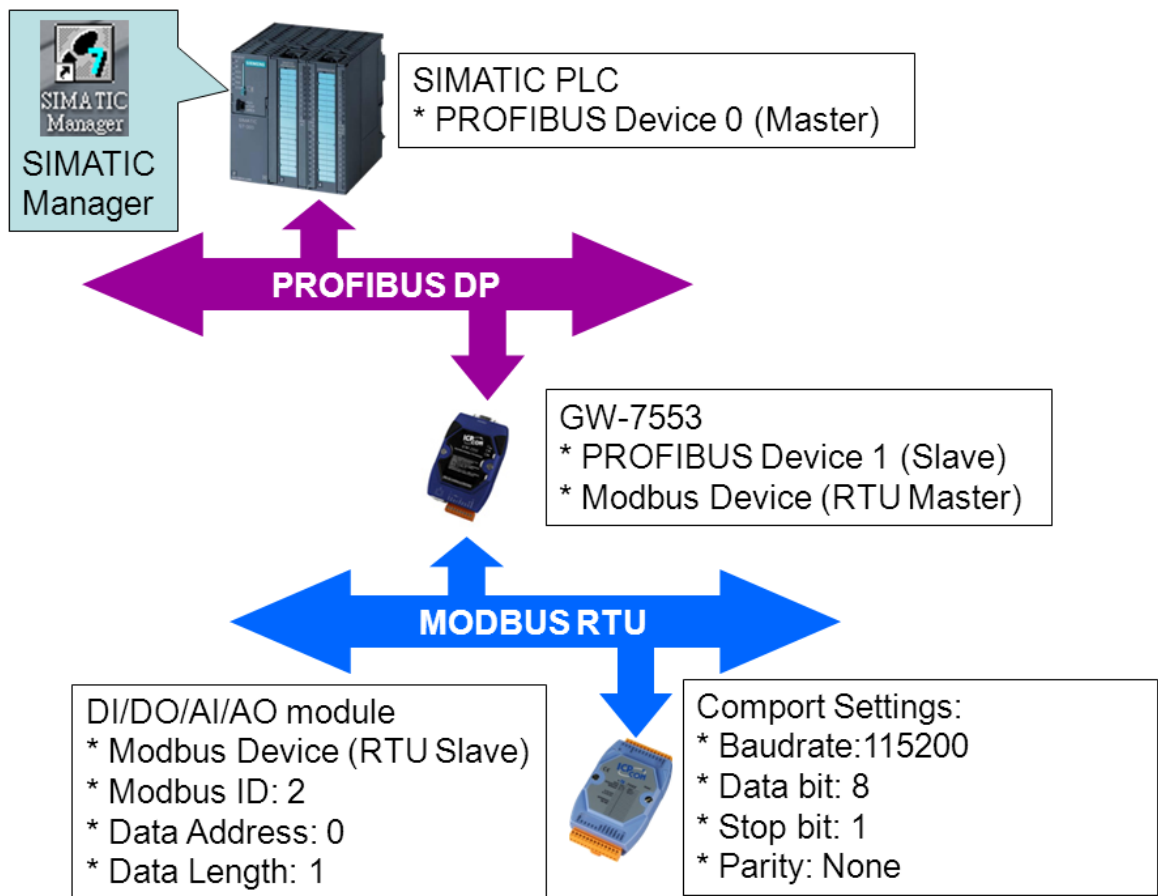

SIMATIC STEP7 Configuration:

Step 1: Setup the GW-7553 module

1. Select GW-7553 module

The screenshot shows the HW Config window for a SIMATIC 300 Station. The main window displays a rack configuration with a CPU 313C-2 DP in slot 2 and DP modules in slots 2.2 and 2.4. A PROFIBUS(1) DP master system is connected to the rack. A red box highlights the GW-7553 module icon in the component palette, with a red arrow pointing to it and the text "Click GW-7553 Icon".

Slot	Module	O...	Fi...	M...	I ...	Q...	Comment
1							
2	CPU 313C-2 DP(1)	6ES7 72.6 2					
2.2	DP				1023		
2.2	DI16/DO16				124...124...		
2.4	Count				768...768...		
3							

2. Add a System setting module

The screenshot shows the HW Config window with the GW-7553 module selected. The component palette on the right is expanded to show the "System setting" module under the "Universal module" category. A red box highlights the "System setting" module, with a red arrow pointing to it and the text "Double click 'System setting'".

Slot	DP ID	Order Number / Designation	I Address	Q Address	Comment
1	24DO	System setting		0...2	
2	8DI	Input Relay/Coil--1 byte	0		
3					

3. Add "Input Relay/Coil—1 byte" module

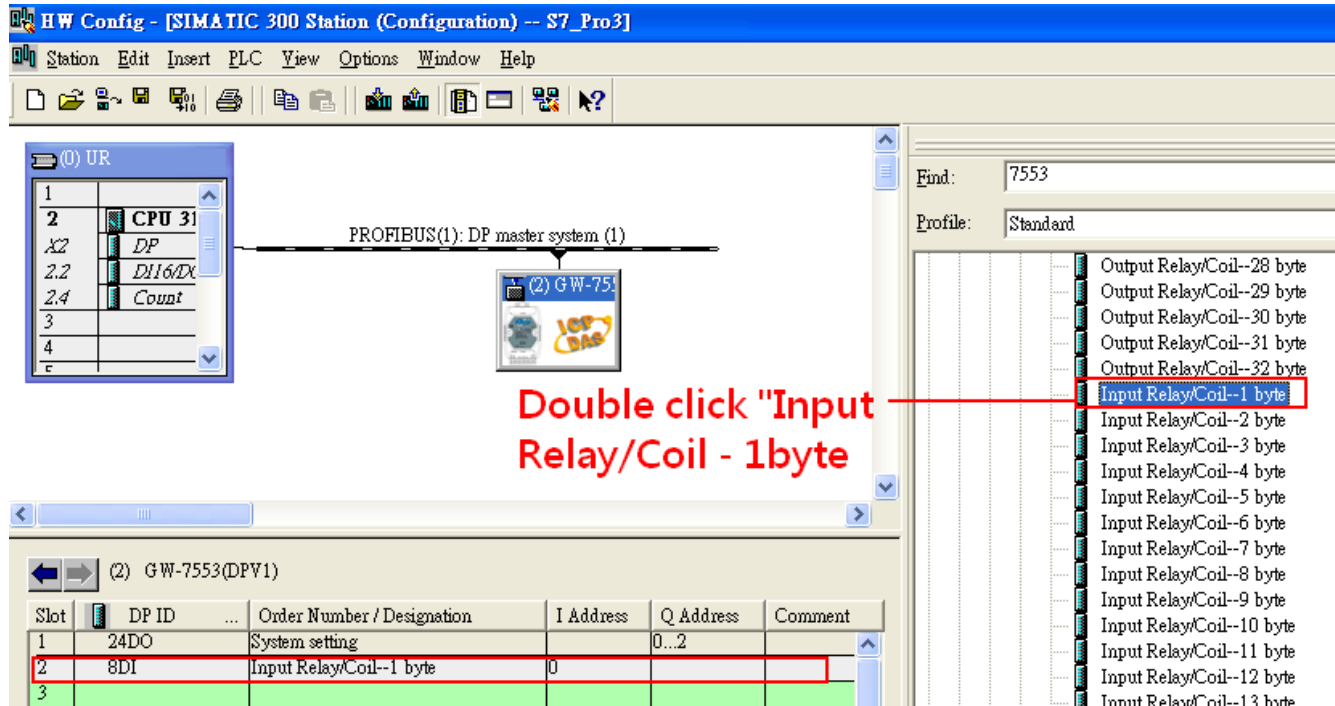

Step 2: Setup the parameters of the GW-7553

1. Double click GW-7553 icon
2. Select "Parameter Assignment"

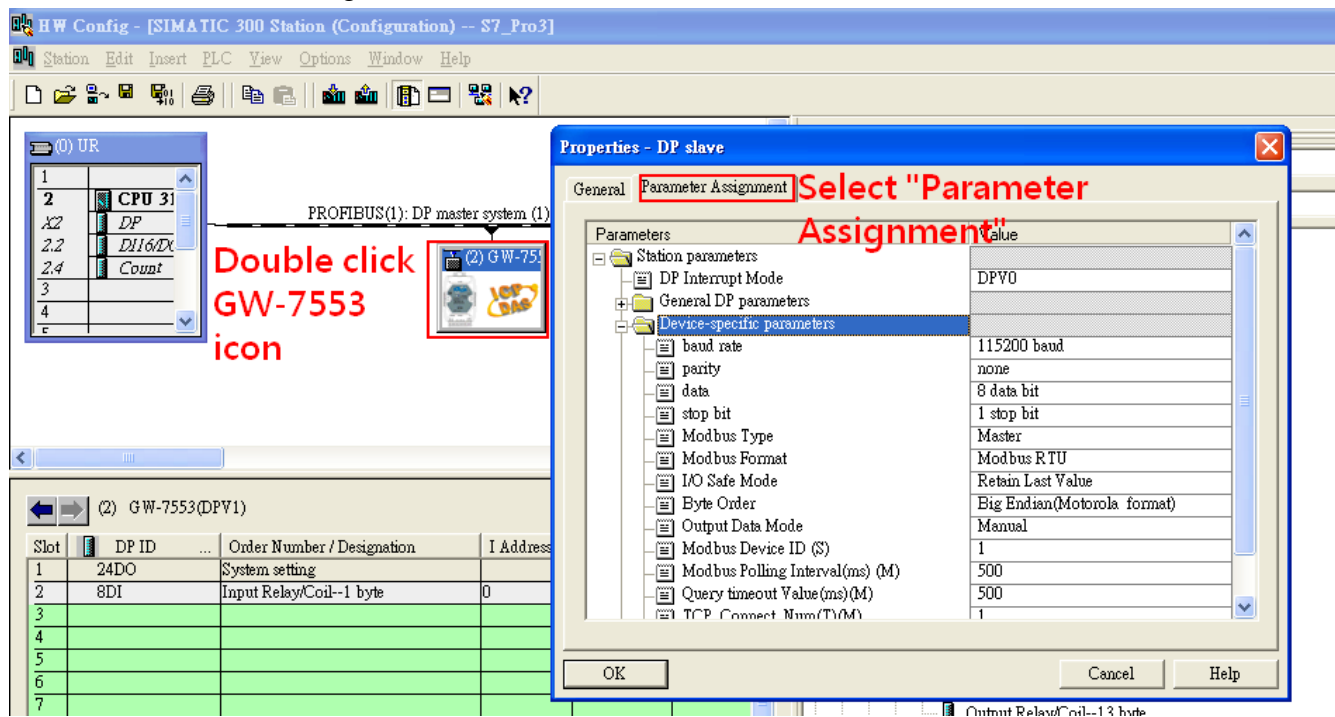

3. Set common parameters of the GW-7553

Common parameters →

Baud rate: 115200; Parity: none; Data: 8 data bit; Stop bit: 1 stop bit; Modbus type: Master
Modbus Format: Modbus RTU; Byte Order: Big Endian

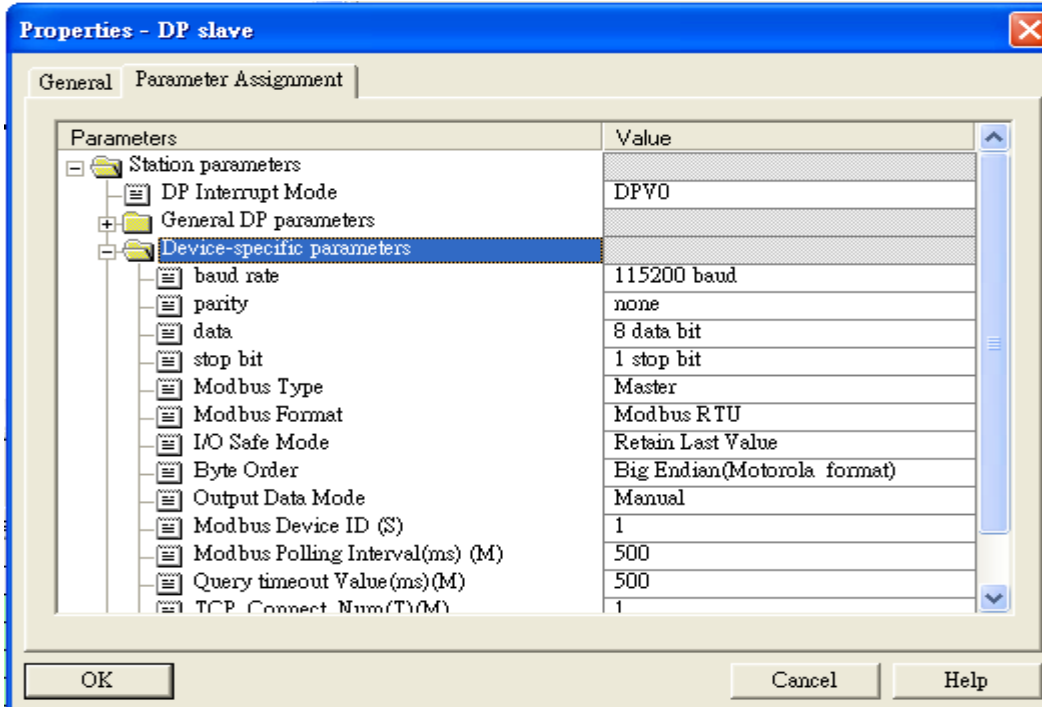

4. Set module parameters of the GW-7553

- (1) Double click "Input Relay/Coil—1 byte" module
- (2) Select "Parameter Assignment"

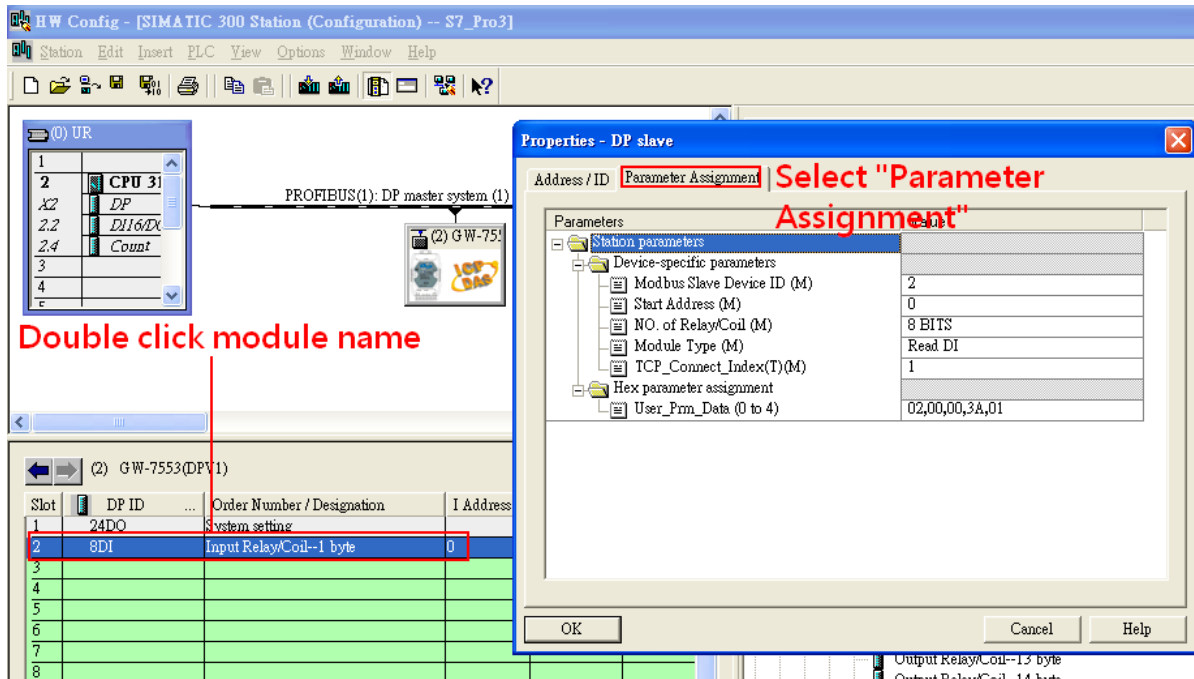

5. Setup "Input Relay/Coil—1 byte" module parameters

Module parameters →

Modbus Slave Device ID: 2; Slave Address: 0 (Protocol address (base 0))

Module Type: Read DI, click ok.

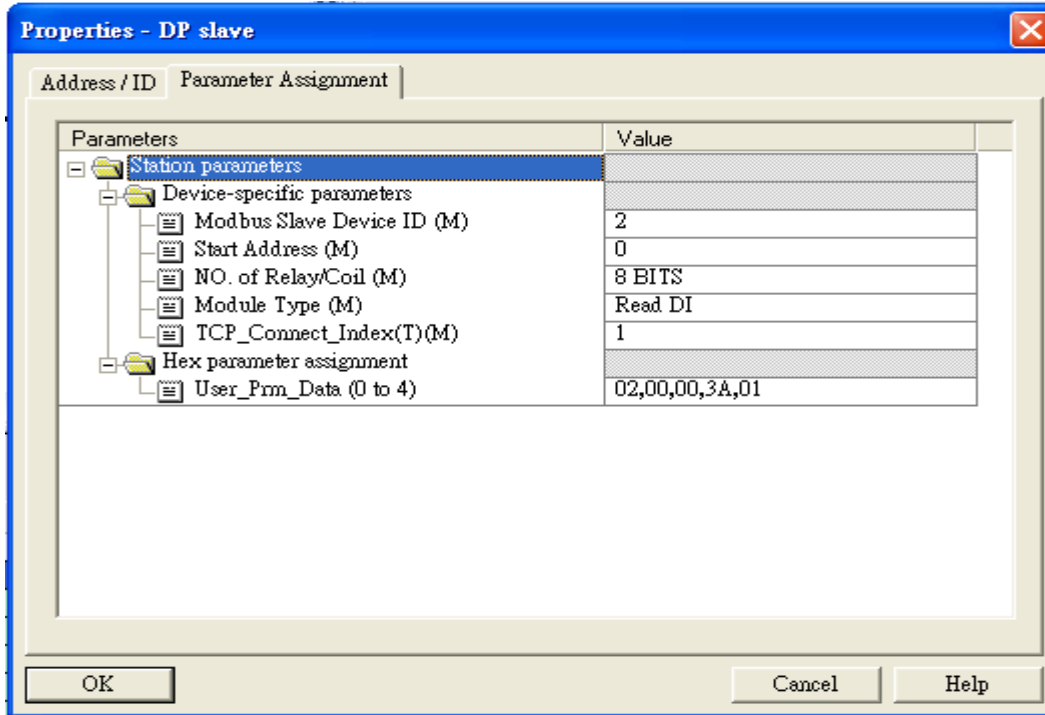

Step 3: Download the HW settings into SIMATIC PLC

1. Save and Compile

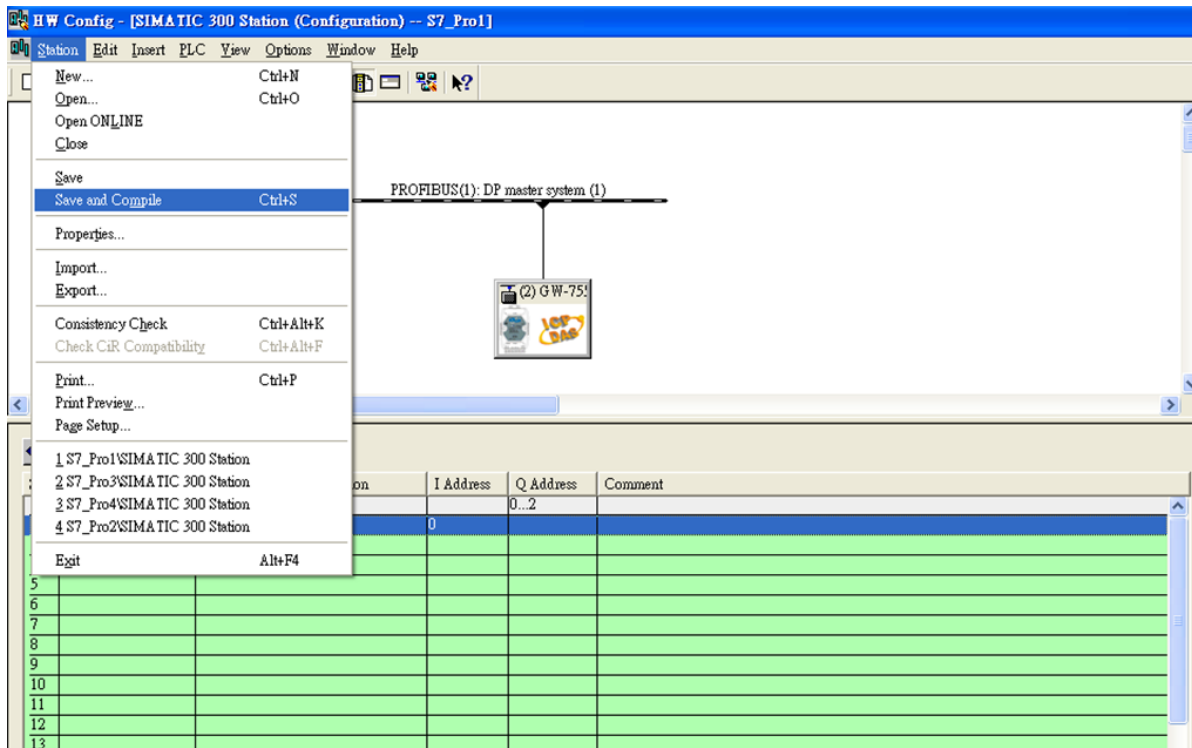

2. HW settings into SIMATIC PLC

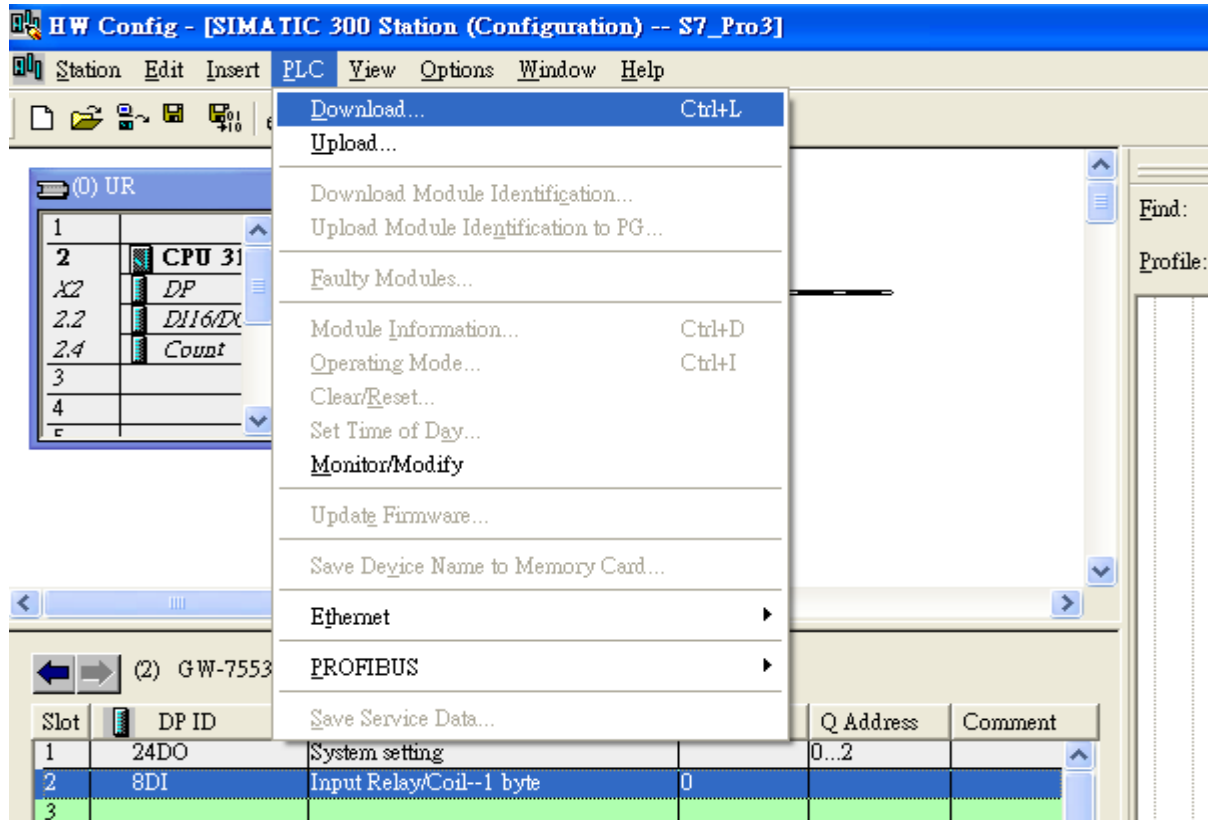

Step 4: Insert a new Organization Block (OB1,OB82,OB86)

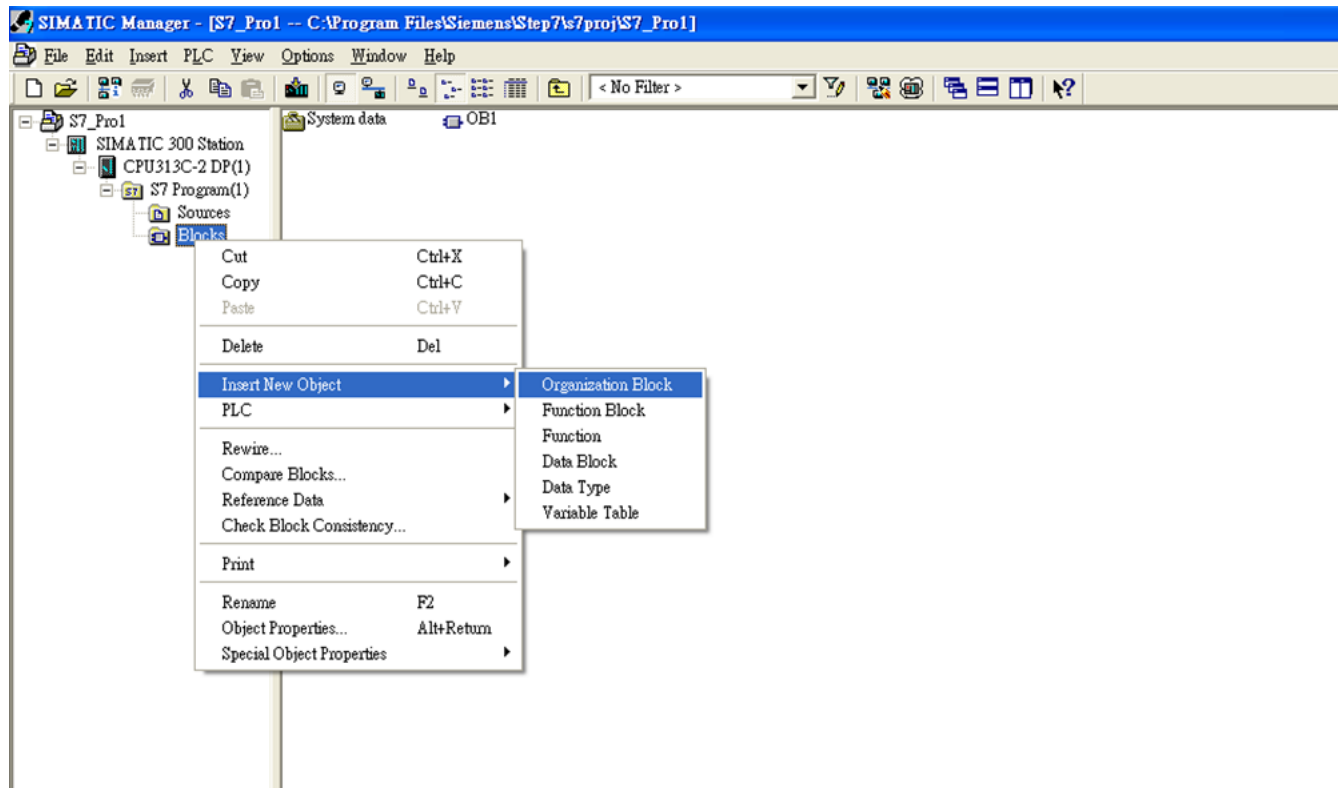

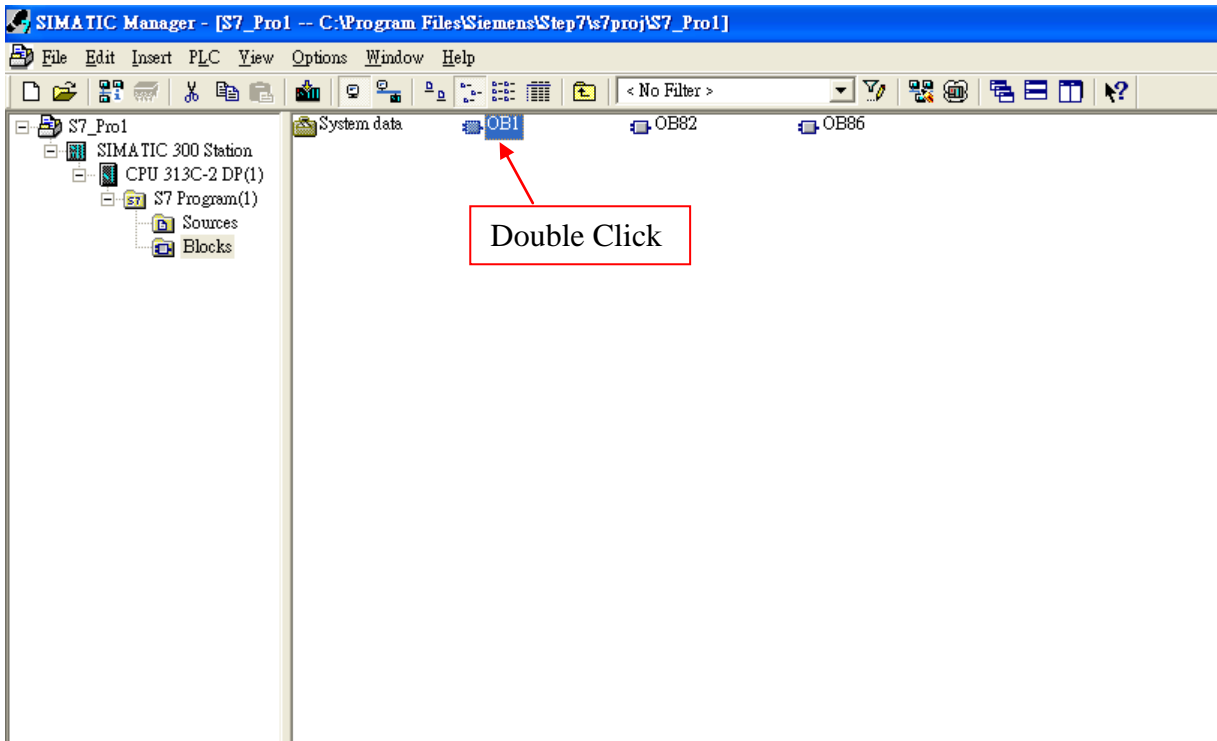
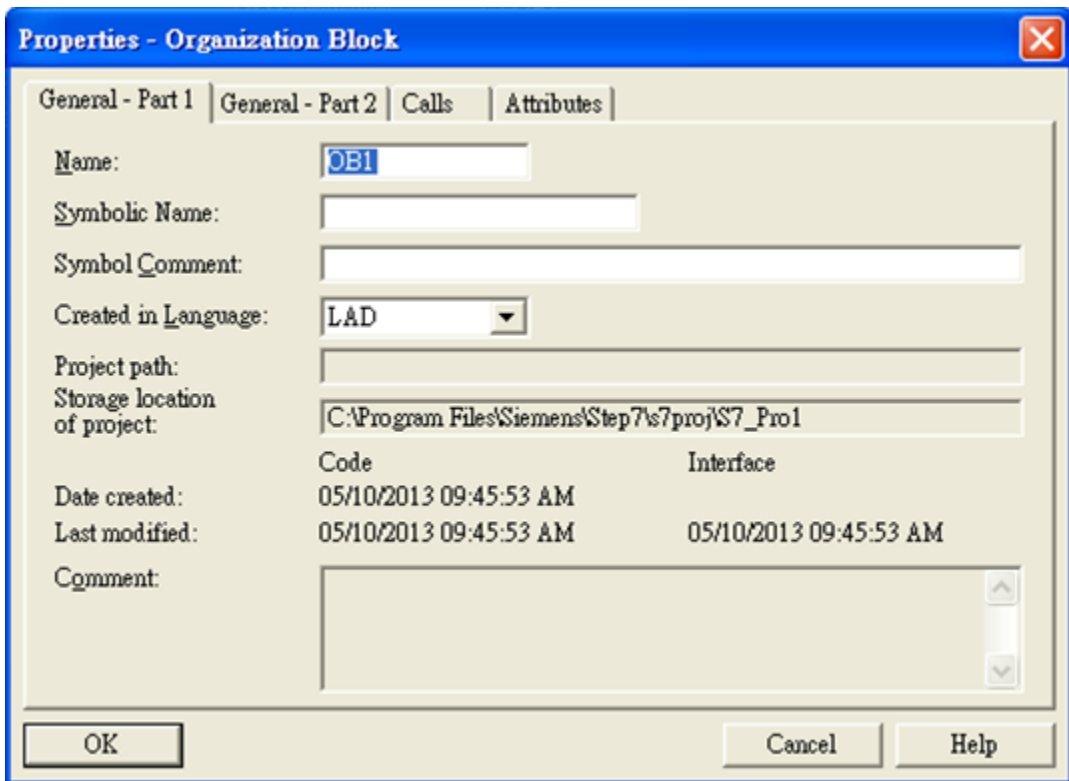

Step 5: Edit OB1

Contents Of: 'Environment\Interface\TEMP'

Name	Data Type	Address	Comment
OBI_MIN...	Int	8.0	Minimum cycle time of OBI (milliseconds)
OBI_MAX...	Int	10.0	Maximum cycle time of OBI (milliseconds)
OBI_DAT...	Date_...	12.0	Date and time OBI started
DIValue	Byte	20.0	
END	Bool	21.0	

OB1 : "Main Program Sweep (Cycle)"

Comment:

Network 1: Title:

Comment:

MOVE EN ENO END IN OUT #DIValue #END

Slot	DP ID	Order Number / Designation	I Address	Q Address
1	24DO	System setting		0..2
2	8DI	Input Relay/Coil--1 byte	0	
3				

Step 6: Download the settings into SIMATIC PLC

Contents Of: 'Environment\Interface\TEMP'

Name	Data Type	Address	Comment
OBI_MIN...	Int	8.0	Minimum cycle time of OBI
OBI_MAX...	Int	10.0	Maximum cycle time of OBI
OBI_DAT...	Date_...	12.0	Date and time OBI start
DIValue	Byte	20.0	
END	Bool	21.0	

OB1 : "Main Program Sweep (Cycle)"

Comment:

Network 1: Title:

Comment:

MOVE EN ENO END IN OUT #DIValue #END

Step 7: Make sure the RUN LED of the GW-7553 is on and the switch of the GW-7553 is at Normal mode.



Now the setting procedure has been finished and the user can read the data of the Modbus DI module at address PIB0.

```

OBI : "Main Program Sweep (Cycle)"
Comment:
Network 1: Title:
Comment:
    MOVE
    IN  OUT
    16#000000ff  16#000000ff
    PIB0 -IN  -#DIValue
    #END
  
```

i:\CPU 313C-2 DP(1)\...\OBI - <offline>

fo 3: Cross-references 4: Address info. 5: Modify 6: Diagnostics 7: Comparison

RUN

Example 3: PLC reads AO module data from GW-7553. (Modbus FC03)

Read a Modbus RTU AO module (PROFIBUS Slave & Modbus RTU/Master)

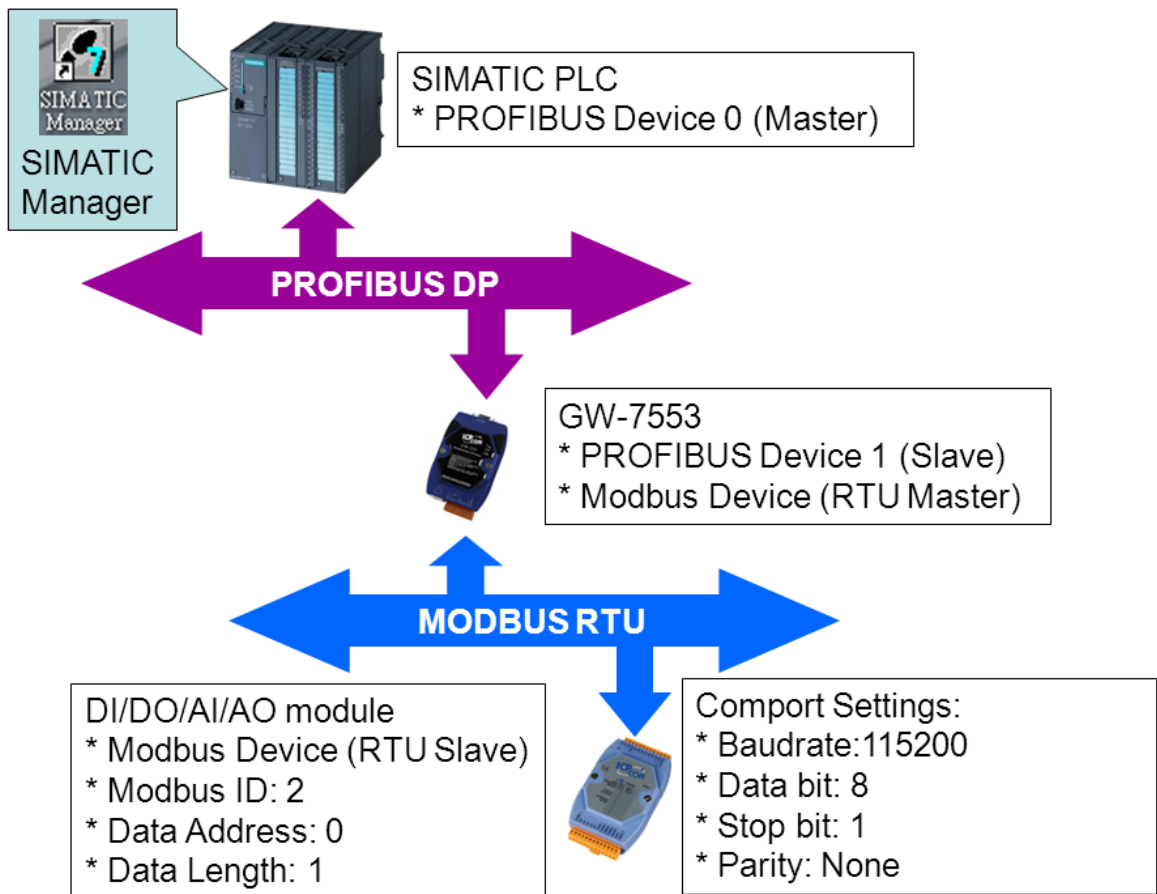

SIMATIC STEP7 Configuration:

Step 1: Setup the GW-7553 module

1. Select GW-7553 module

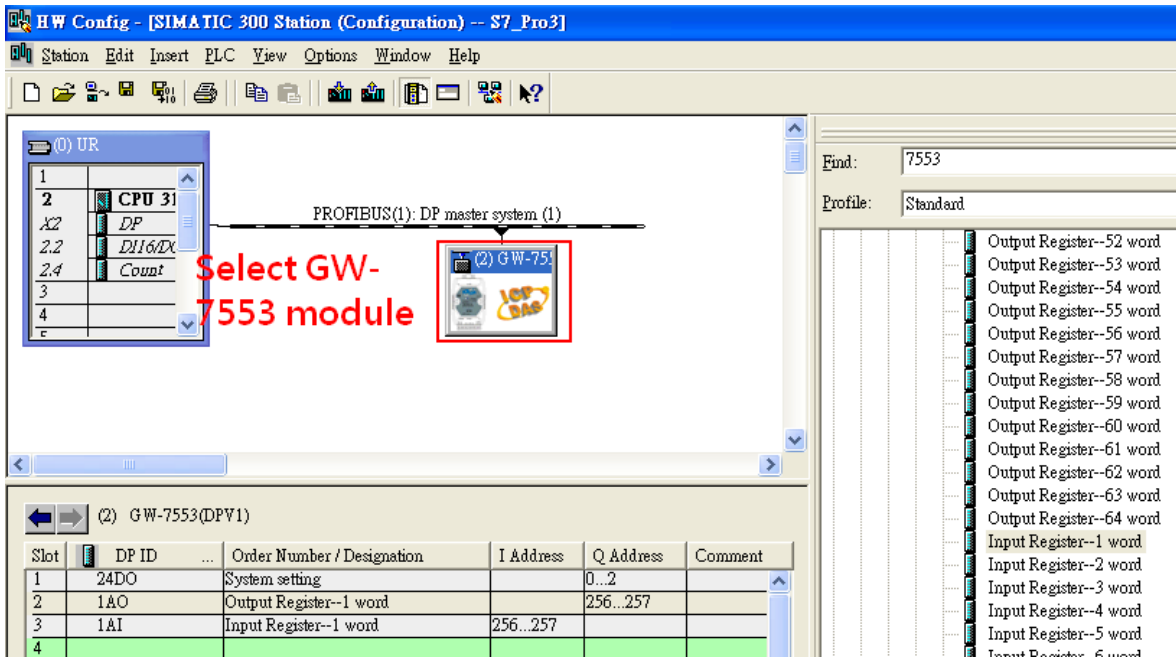

2. Add a System setting module

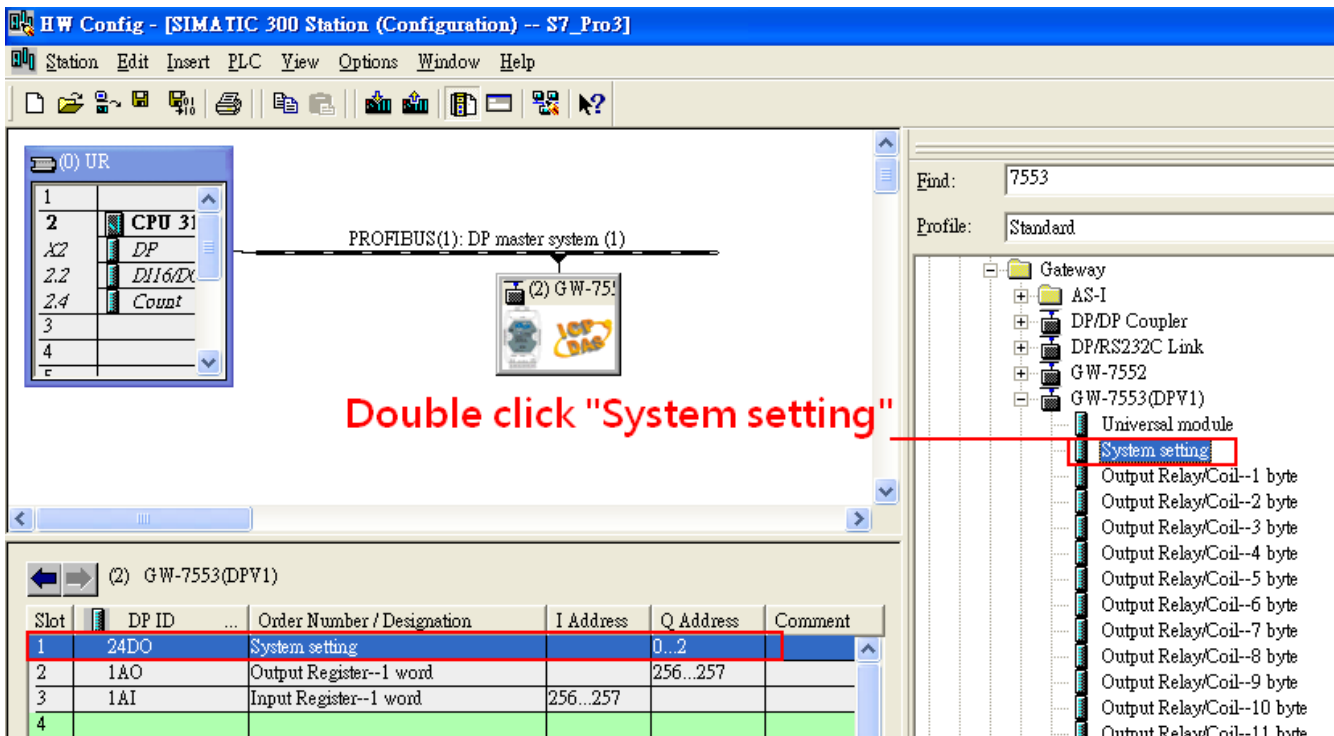

3. Add "Output Register – 1 word" and "Input Register – 1 word"

Find: 7553
Profile: Standard

Slot	DP ID	Order Number / Designation	I Address	Q Address	Comment
1	24DO	System setting		0...2	
2	1AO	Output Register--1 word		256...257	
3	1AI	Input Register--1 word	256...257		
4					

Find: 7553
Profile: Standard

Slot	DP ID	Order Number / Designation	I Address	Q Address	Comment
1	24DO	System setting		0...2	
2	1AO	Output Register--1 word		256...257	
3	1AI	Input Register--1 word	256...257		
4					

Step 2: Setup the parameters of the GW-7553

1. Double click GW-7553 icon
2. Select "Parameter Assignment"

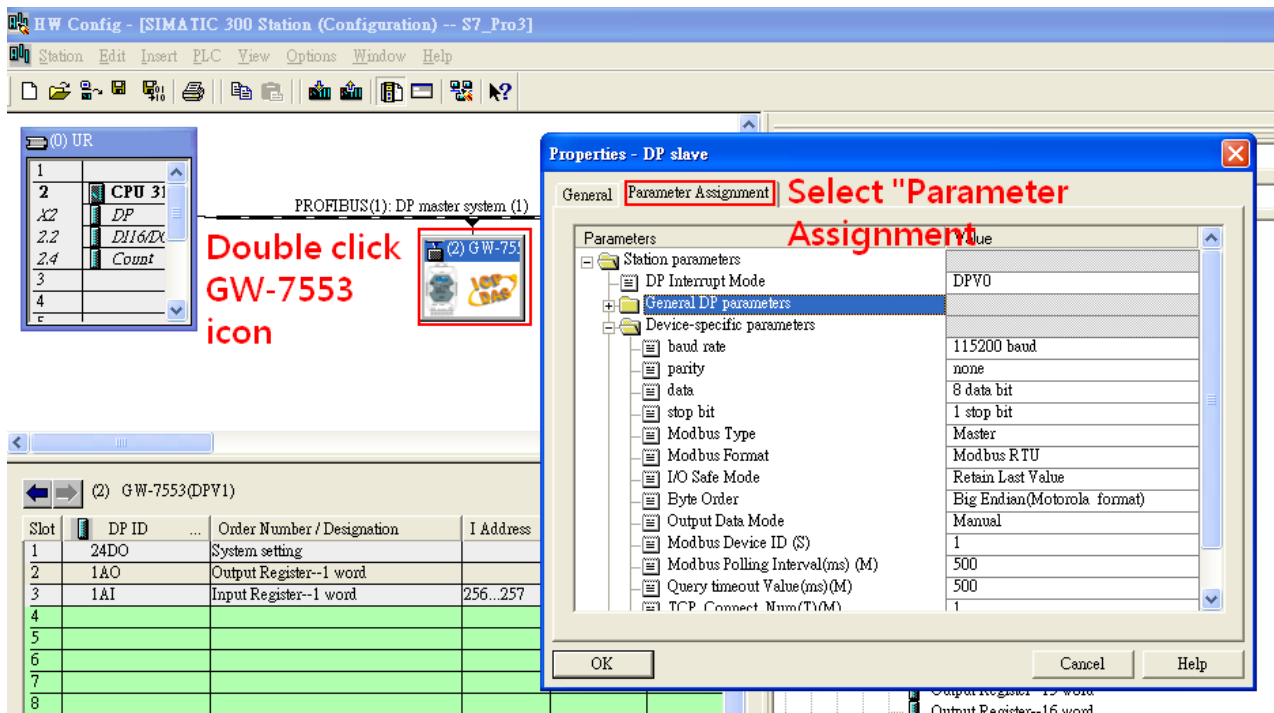

3. Set common parameters of the GW-7553

Common parameters →

Baud rate: 115200; Parity: none; Data: 8 data bit; Stop bit: 1 stop bit; Modbus type: Master

Modbus Format: Modbus RTU; Byte Order: Big Endian

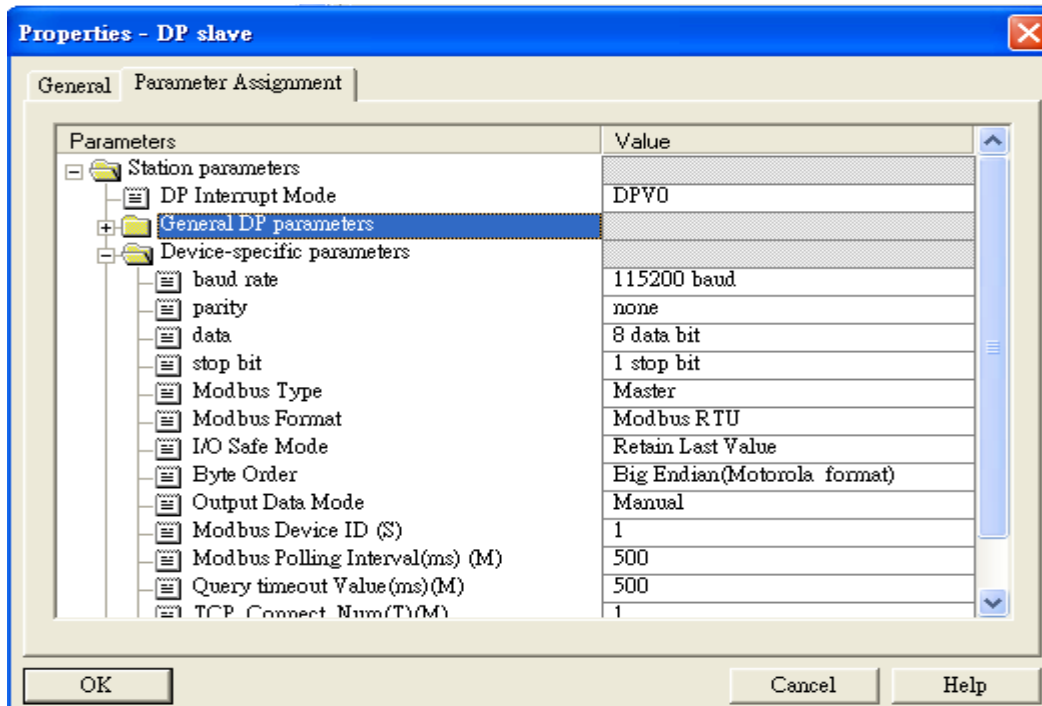

4. Set module parameters of the GW-7553

(1) Double click "Output Register – 1 word" module

(2) Select "Parameter Assignment"

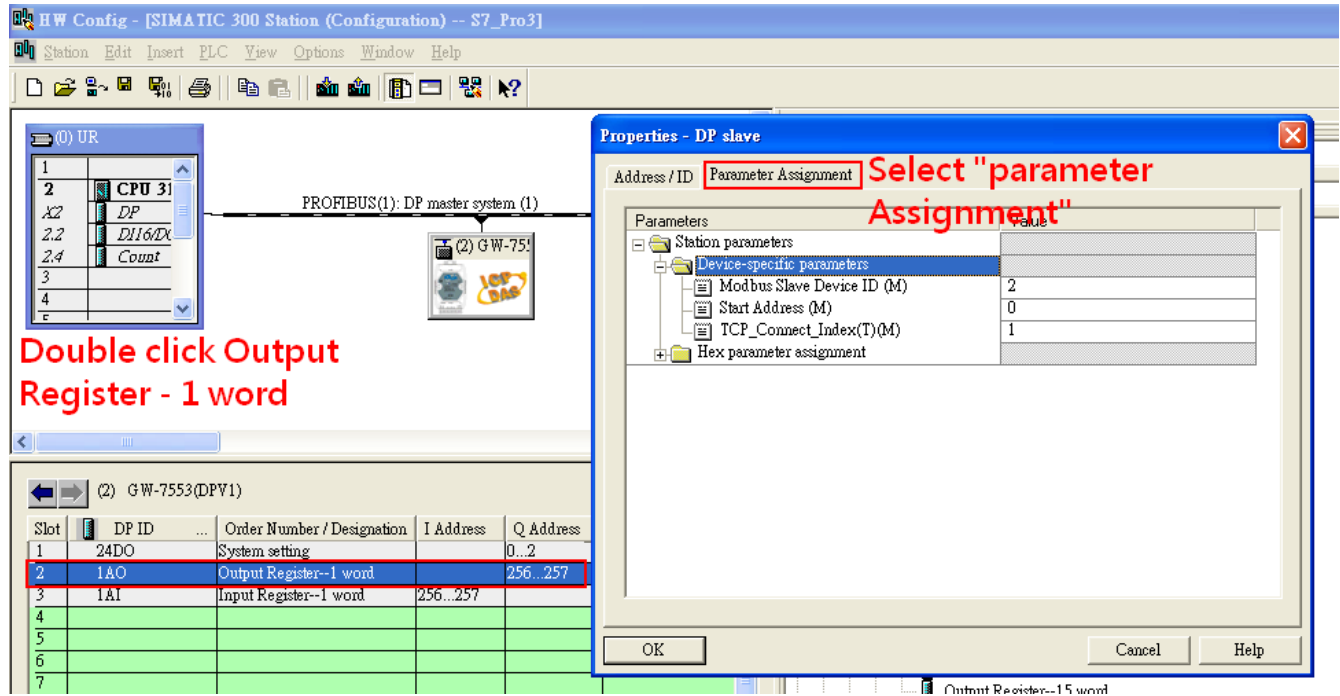

5. Setup "Output Register – 1 word" module parameters

Module parameters →

Modbus Slave Device ID: 2; Slave Address: 0 (Protocol address (base 0)), click ok.

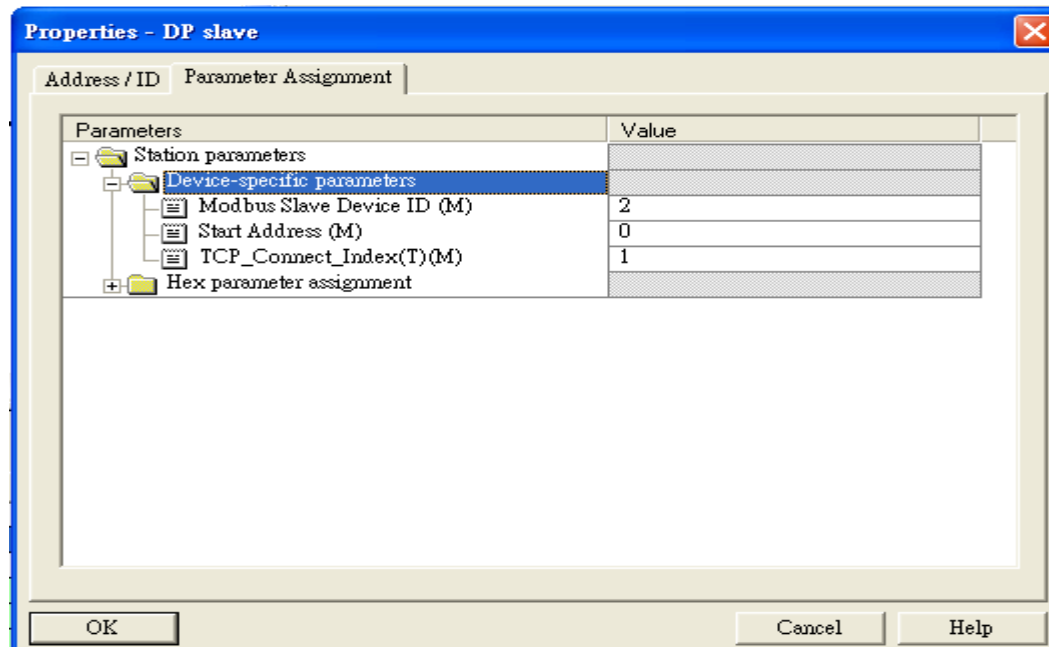

6. Set module parameters of the GW-7553

(1) Double click "Input Register – 1 word" module

(2) Select "Parameter Assignment"

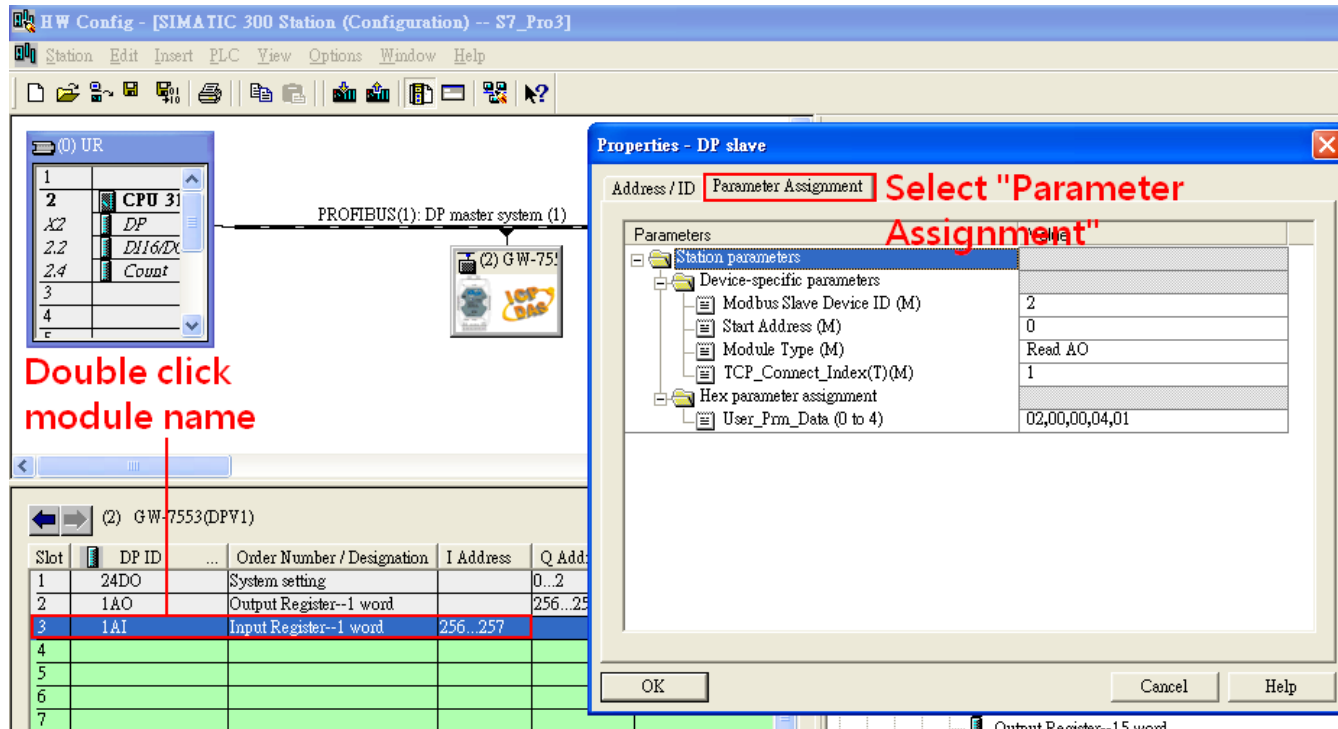

5. Setup "Input Register – 1 word" module parameters

Module parameters →

Modbus Slave Device ID: 2; Slave Address: 0 (Protocol address (base 0)), click ok.

Module Type: Read AO, click ok.

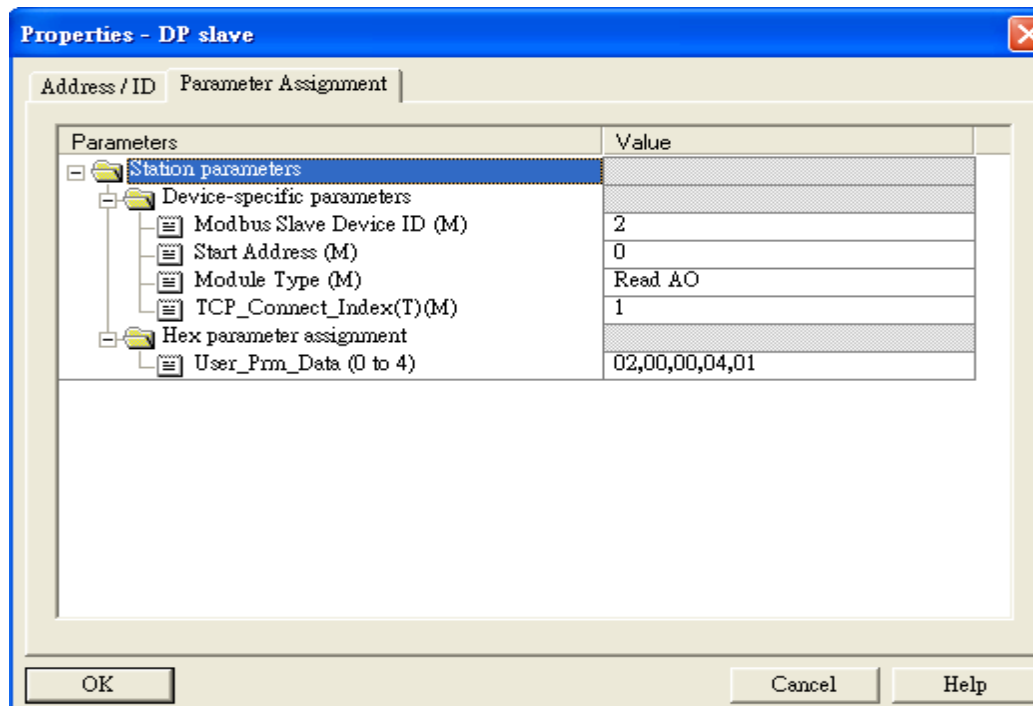

Step 3: Download the HW settings into SIMATIC PLC

1. Save and Compile

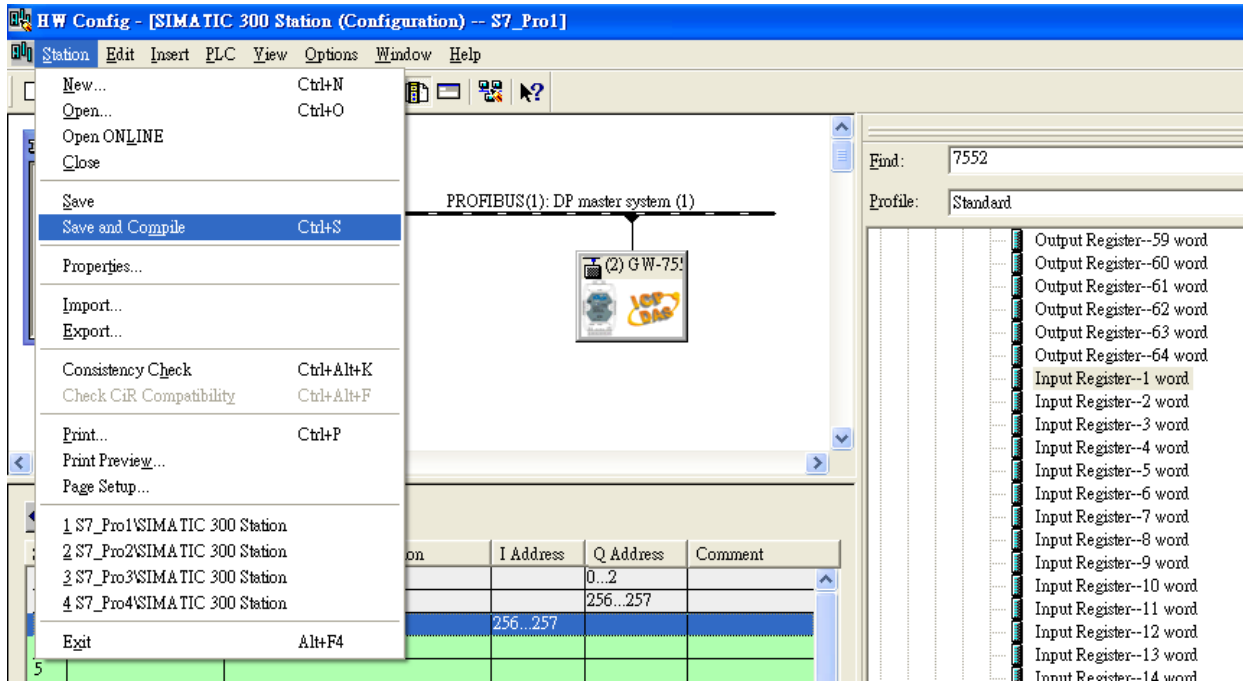

2. HW settings into SIMATIC PLC

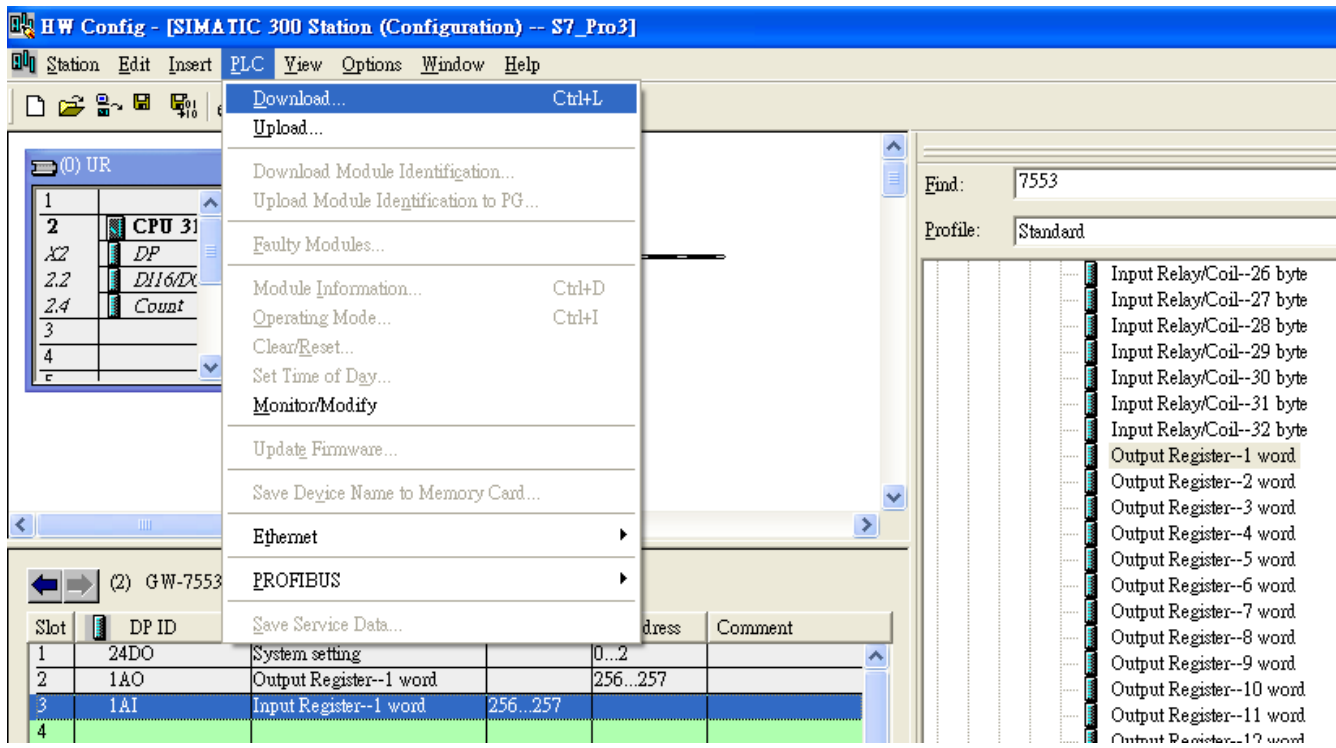

Step 4: Insert a new Organization Block (OB1,OB82,OB86)

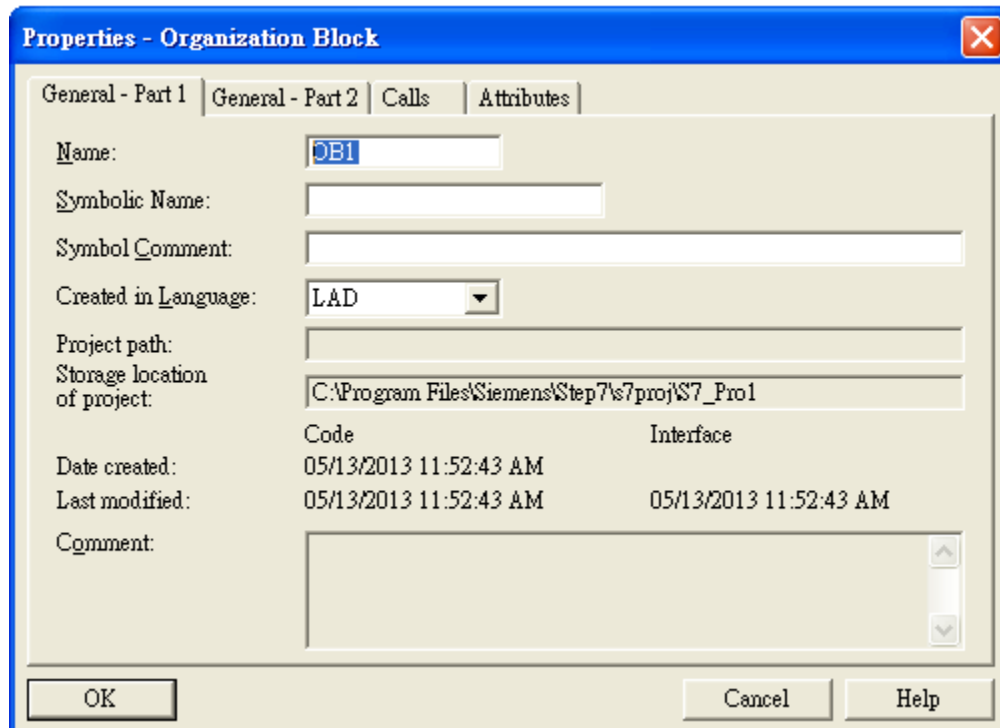
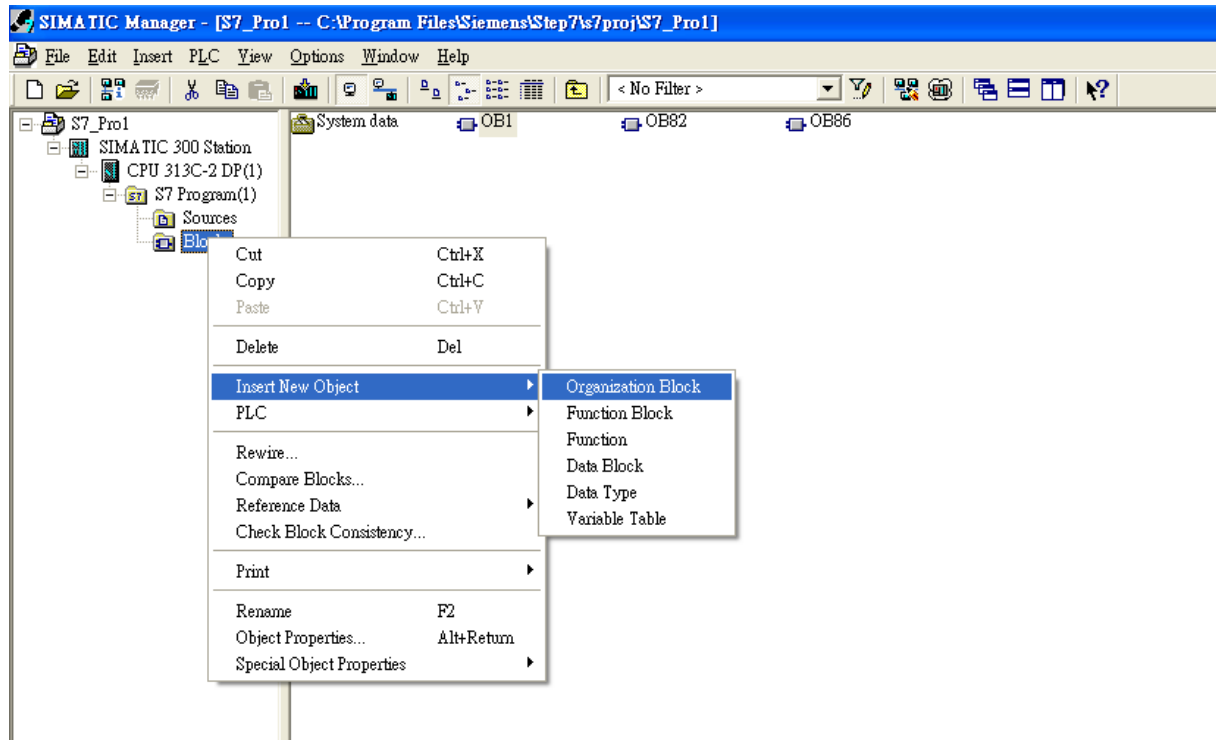

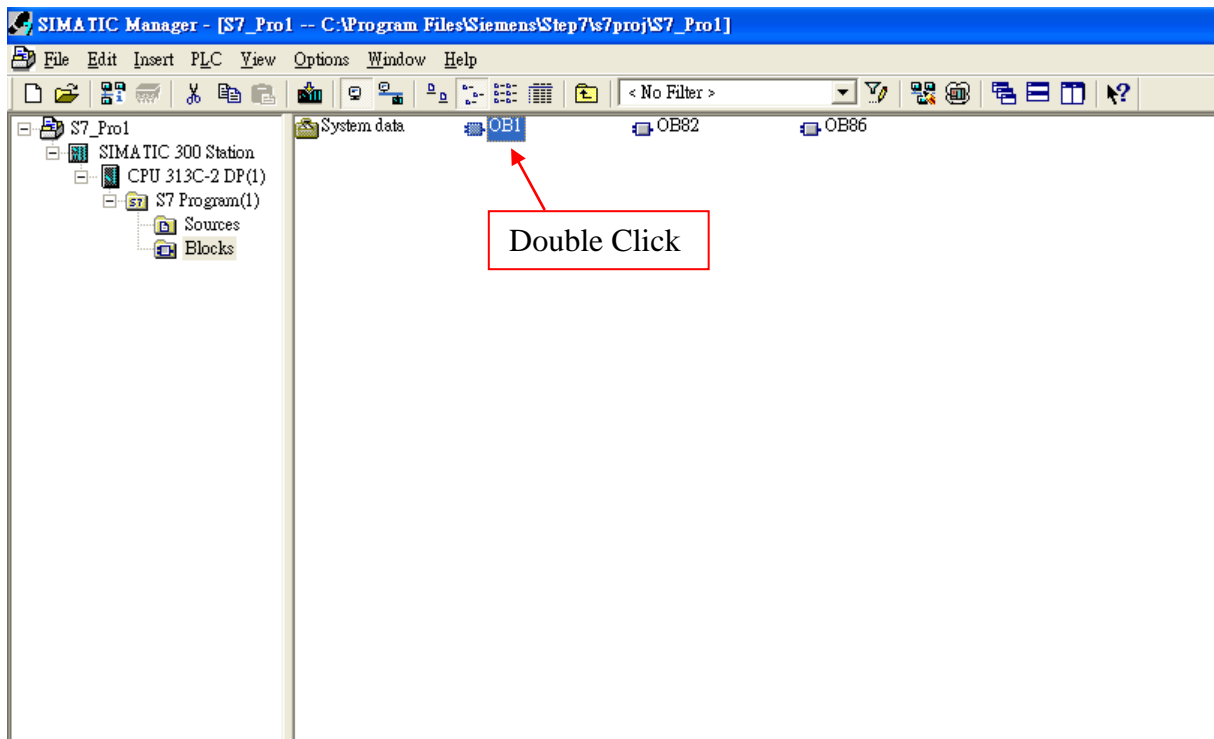

Step 5: Edit OB1

Variables used in the example LD Program:

Name	Data Type	Address	Comment
END	Bool	20.0	
INIT	Bool	20.1	
Tri	Int	22.0	
AIValue	Word	24.0	

Network 1: Reset Counter(C1)

Reset Counter (C1)

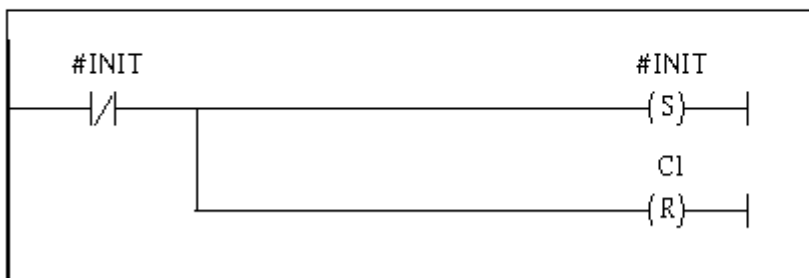

Network 2 : Title:

Comment:

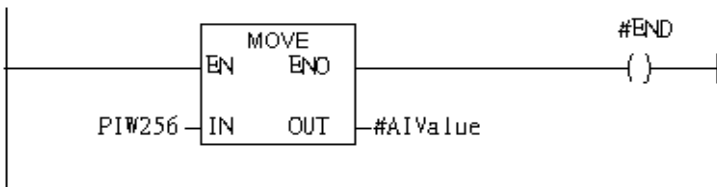

Network 3 : QW0 add "1" then PLC will send QW3 out.

1 word AO

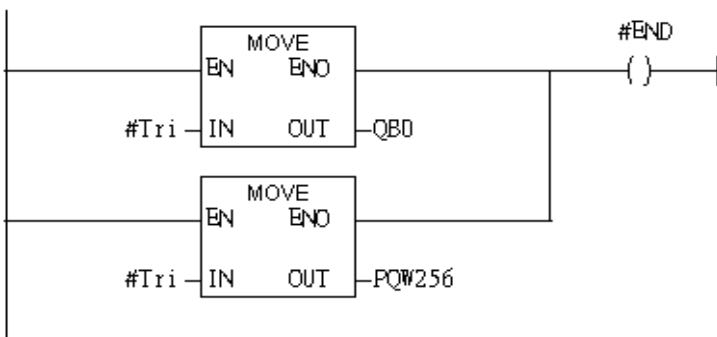

Network 4 : Timer T1 & T2

Using T2 trigger T1

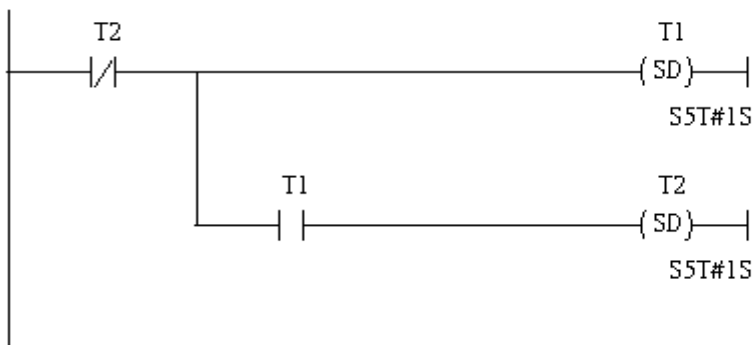

Network 5 : Counter C1

If counter(C1) add "1" and Tri will add "1" ,too.

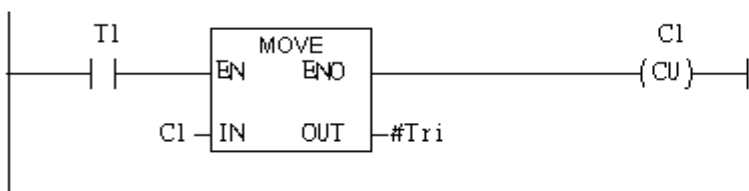

Network 6 : Compare Tri & 256

If Tri is equal to 256, C1 will reset

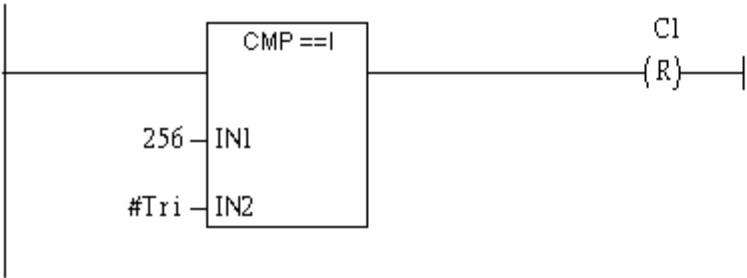

Step 6: Download the settings into SIMATIC PLC

The screenshot shows the SIMATIC Manager interface. The 'Download' menu is open, listing options such as 'Select Online CPU...', 'Establish Connection to Configured CPU', 'CPU Messages...', 'Display Force Values', 'Monitor/Modify Variables', 'Module Information...', 'Operating Mode...', 'Clear/Reset...', and 'Set Time of Day...'. The 'Contents Of: 'Environment\Interface\TEMP'' table is visible in the background.

Name	Data Type	Address	Comment
OB1_MAX...	Int	10.0	Maximum cycle time of OB1
OB1_DAT...	Date_...	12.0	Date and time OB1 started
END	Bool	20.0	
INIT	Bool	20.1	
Tri	Int	22.0	
AIValue	Word	24.0	

Below the table, the ladder logic for Network 2 is shown. It features a normally closed contact for '#INIT' leading to a set coil '(S)' for '#INIT'. A normally open contact for 'C1' leads to a reset coil '(R)' for 'C1'. The network title is 'Network 2 : Title:' and the comment field is empty. Below this, a 'MOVE' instruction is shown with 'PIW256' as the input and '#AIValue' as the output.

Step 7: Make sure the RUN LED of the GW-7553 is on and the switch of the GW-7553 is at Normal mode.



Now the setting procedure has been finished and the user can write the data to the Modbus AO module at address PIW256.

Network 2: Title:

Comment:

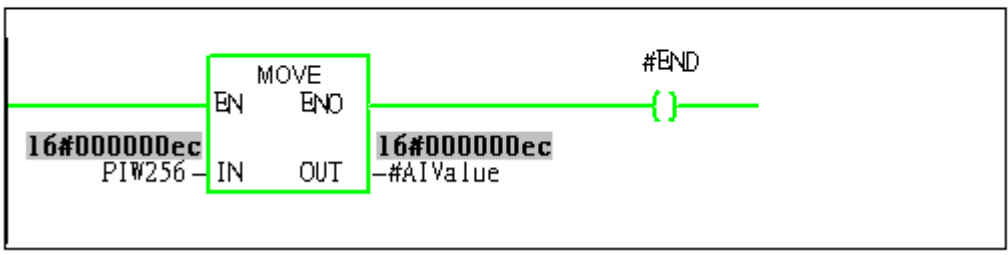

Example 4: PLC reads AI module data from GW-7553.

(Modbus FC04)

Read a Modbus RTU AI module (PROFIBUS Slave & Modbus RTU/Master)

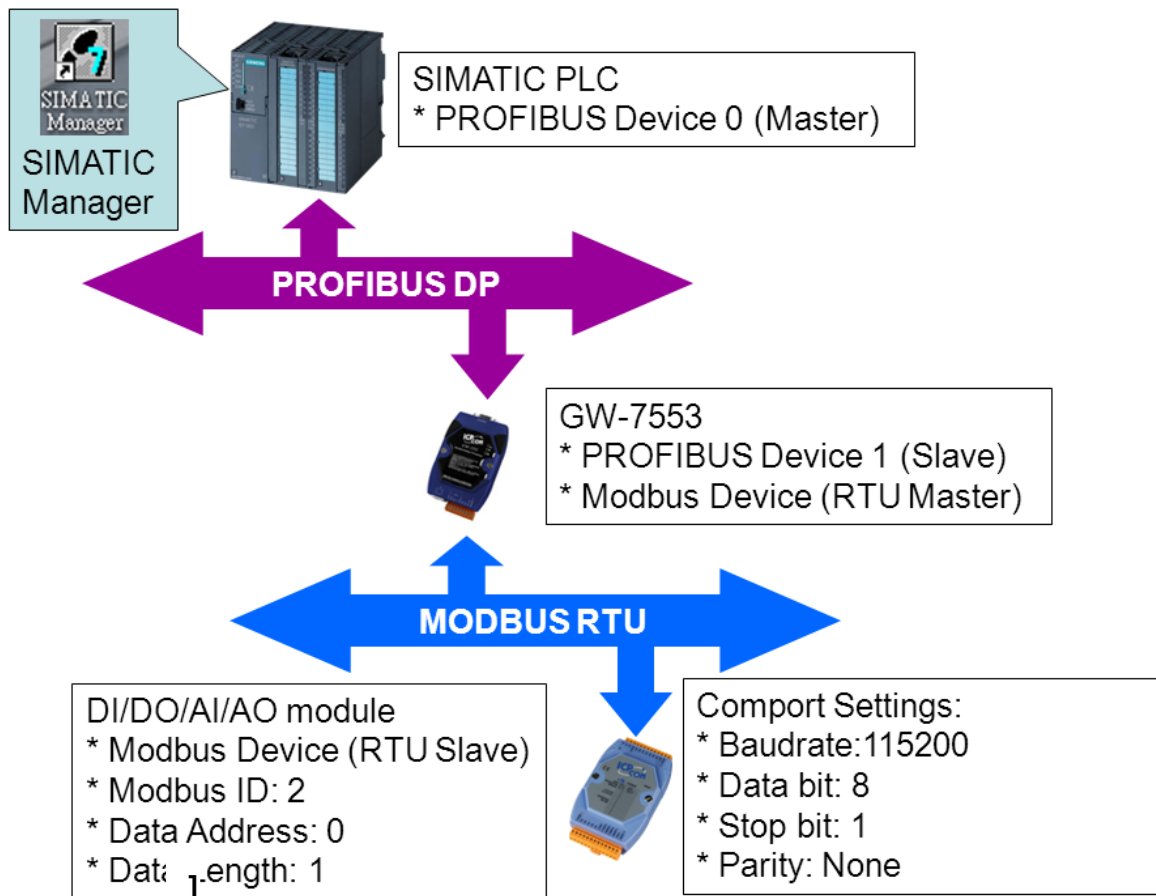

SIMATIC STEP7 Configuration:

Step 1: Setup the GW-7553 module

1. Select GW-7553 module

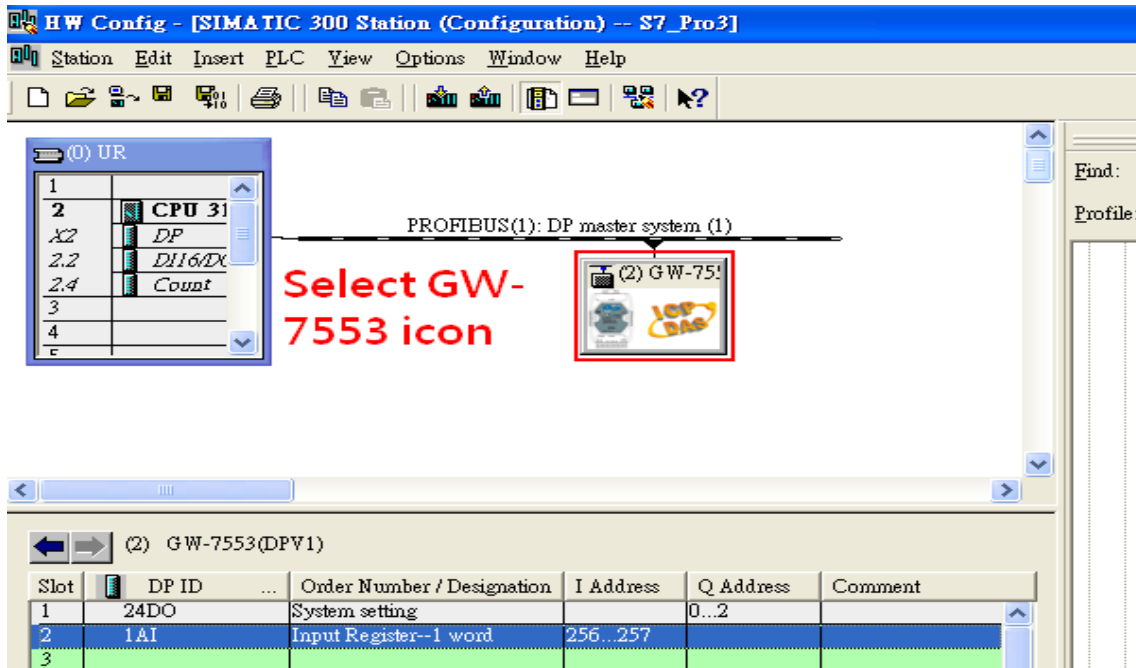

2. Add a System setting module

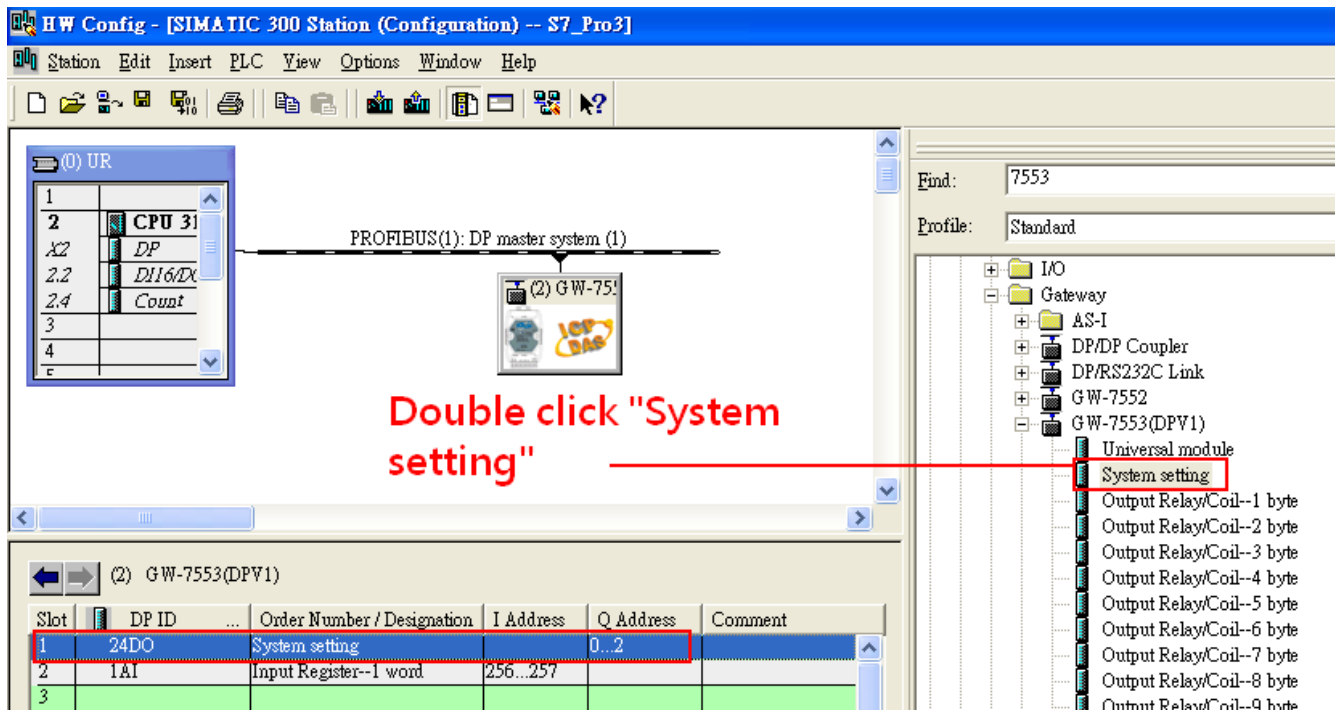

3. Add "Input Register—1 word" module

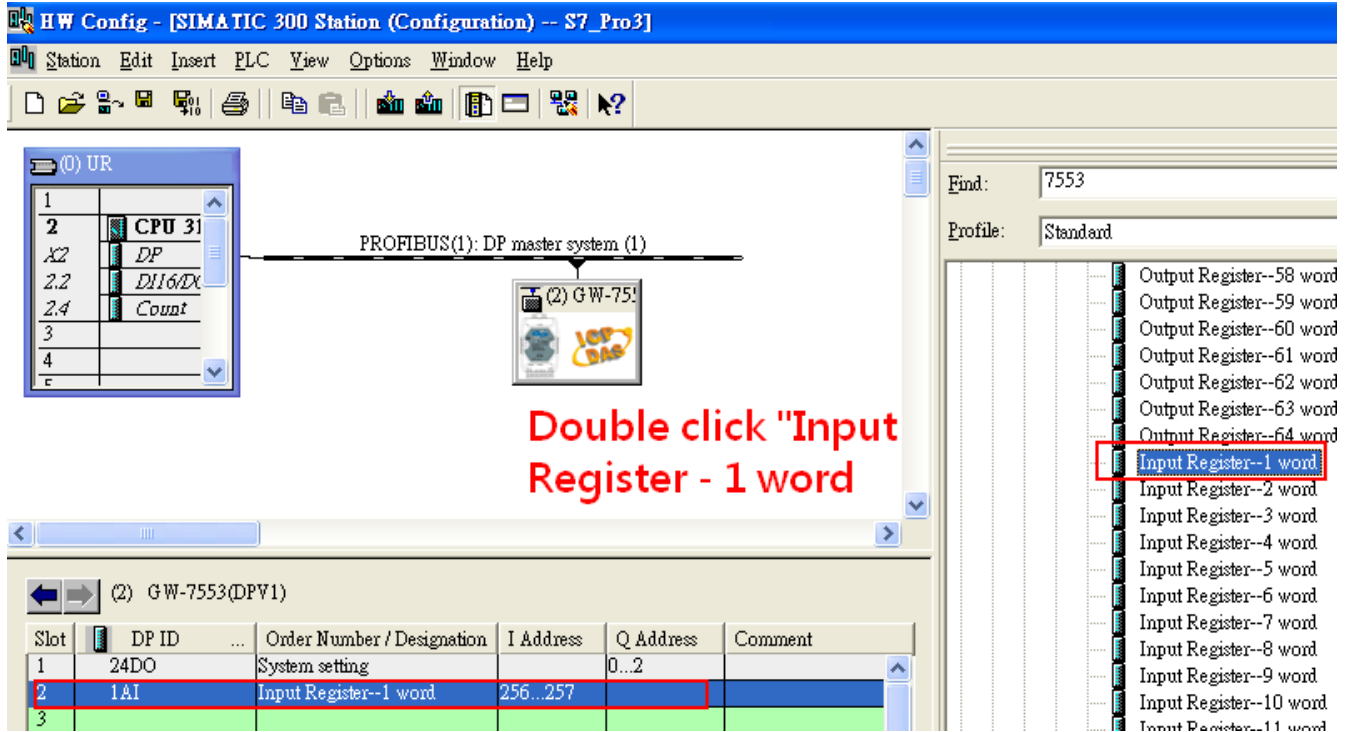

Step 2: Setup the parameters of the GW-753

1. Double click GW-753 icon
2. Select "Parameter Assignment"

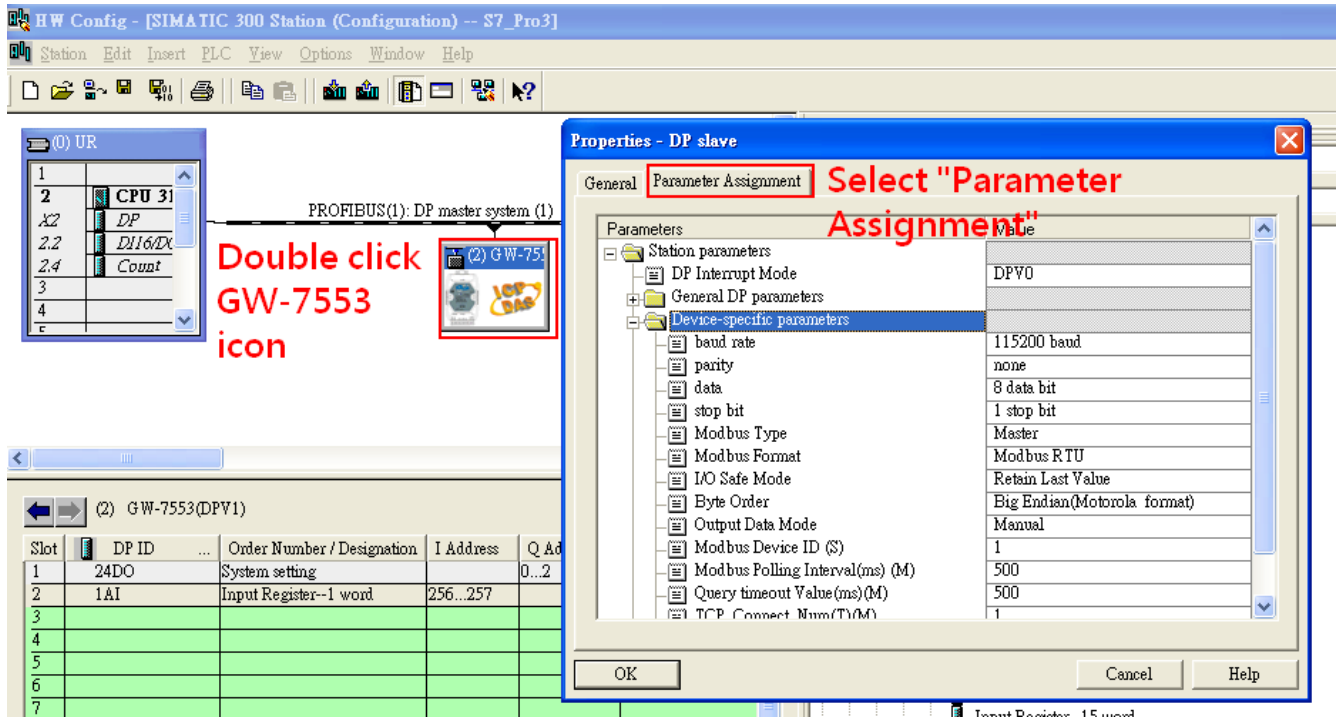

3. Set common parameters of the GW-7553

Common parameters →

Baud rate: 115200; Parity: none; Data: 8 data bit; Stop bit: 1 stop bit; Modbus type: Master

Modbus Format: Modbus RTU; Byte Order: Big Endian

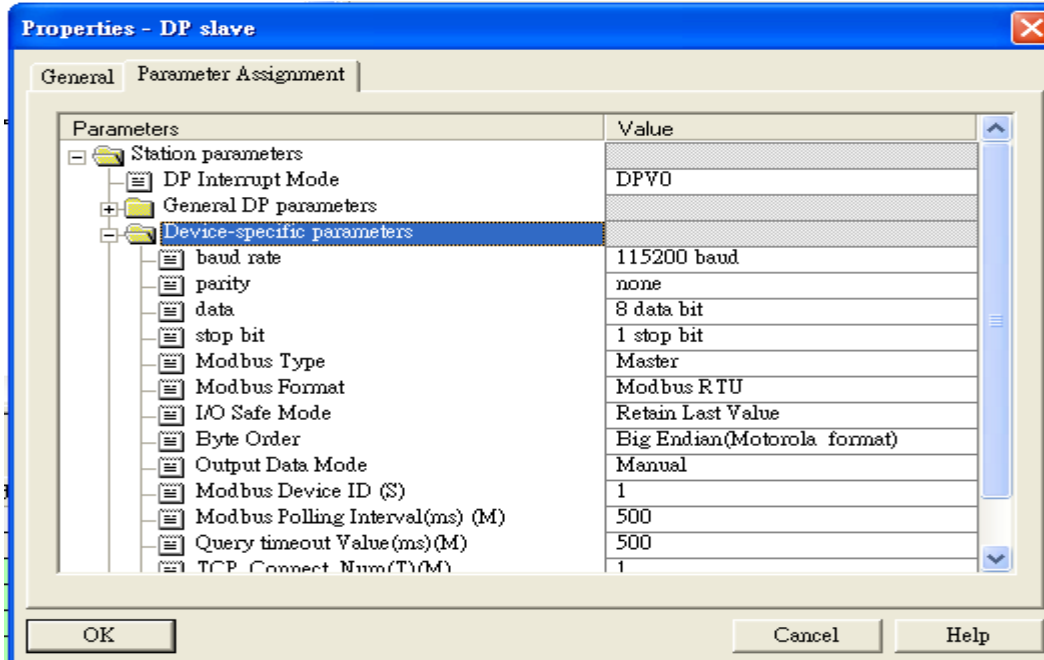

4. Set module parameters of the GW-7553

(1) Double click "input register—1 word" module

(2) Select "Parameter Assignment"

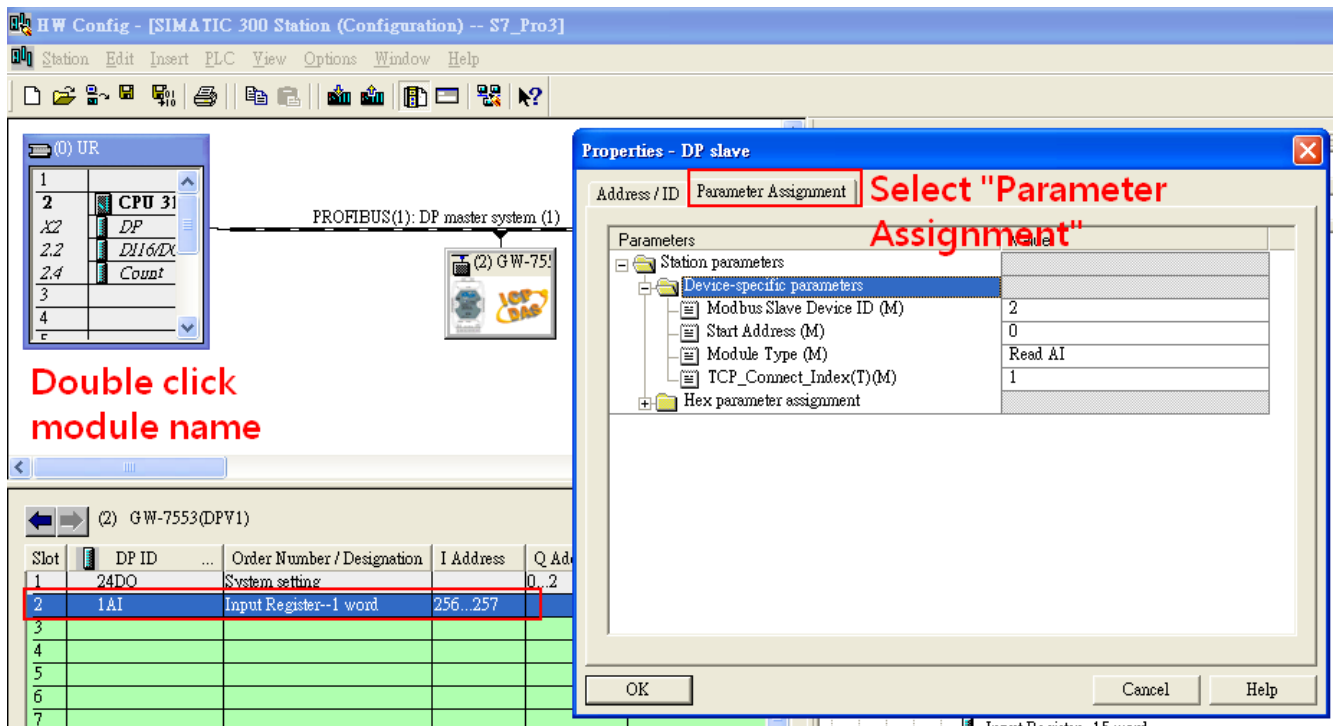

5. Setup “input register—1 word” module parameters

Module parameters →

Modbus Slave Device ID: 1; Slave Address: 0 (Protocol address (base 0))

Module Type: Read AI, click ok.

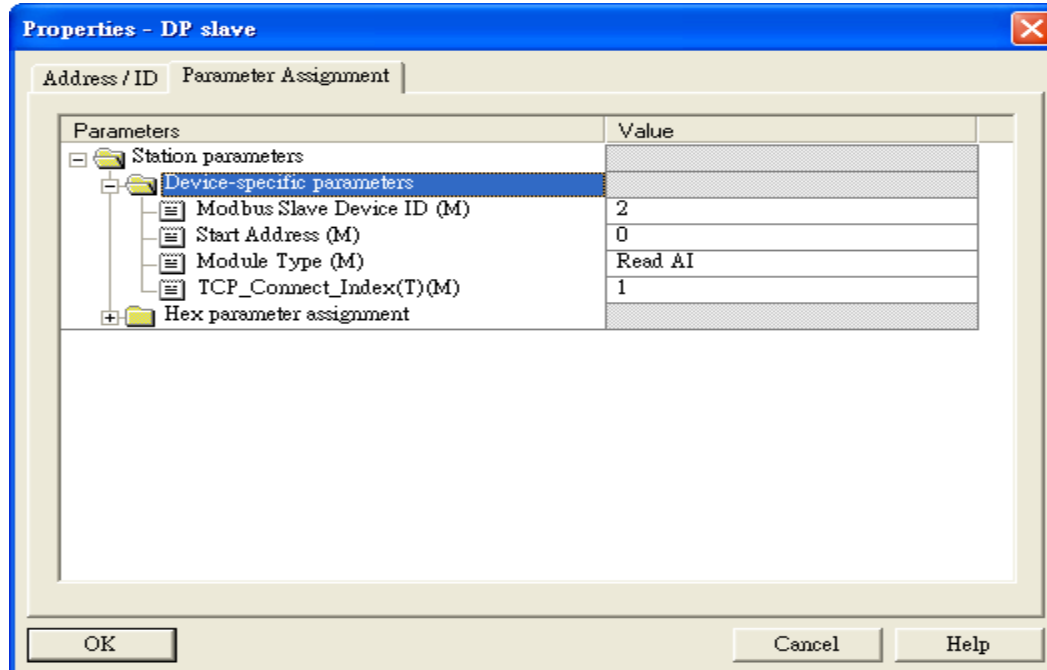

Step 3: Download the HW settings into SIMATIC PLC

1. Save and Compile

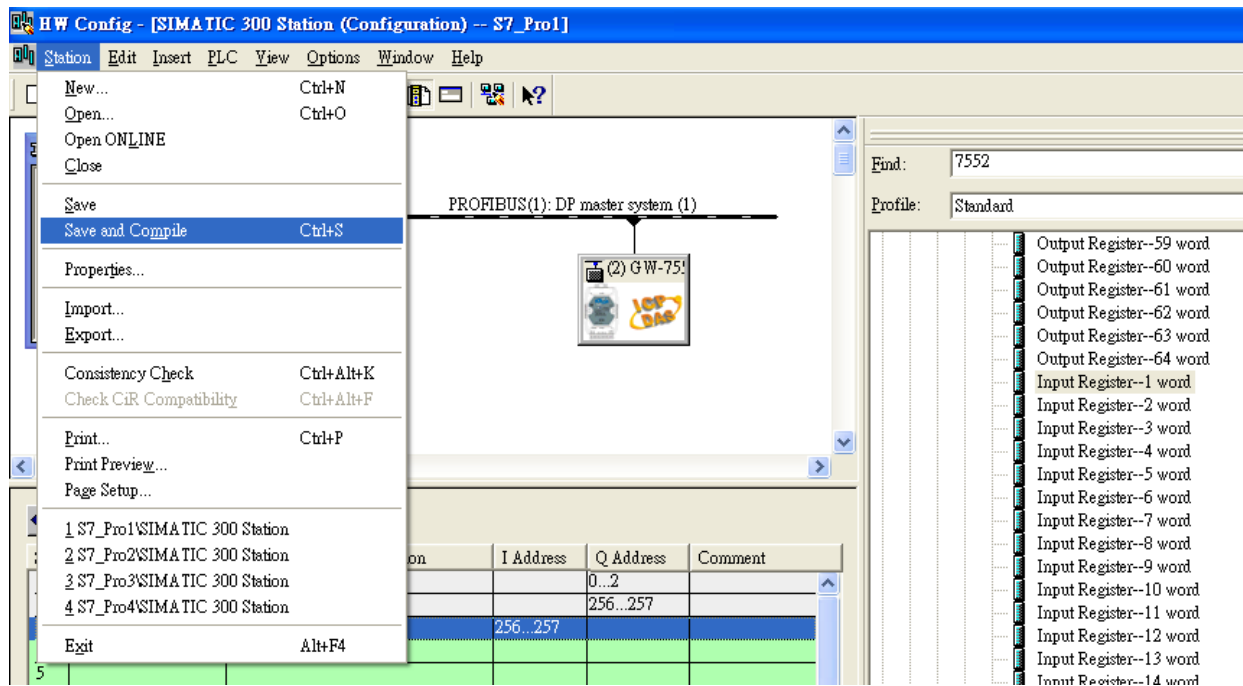

2. HW settings into SIMATIC PLC

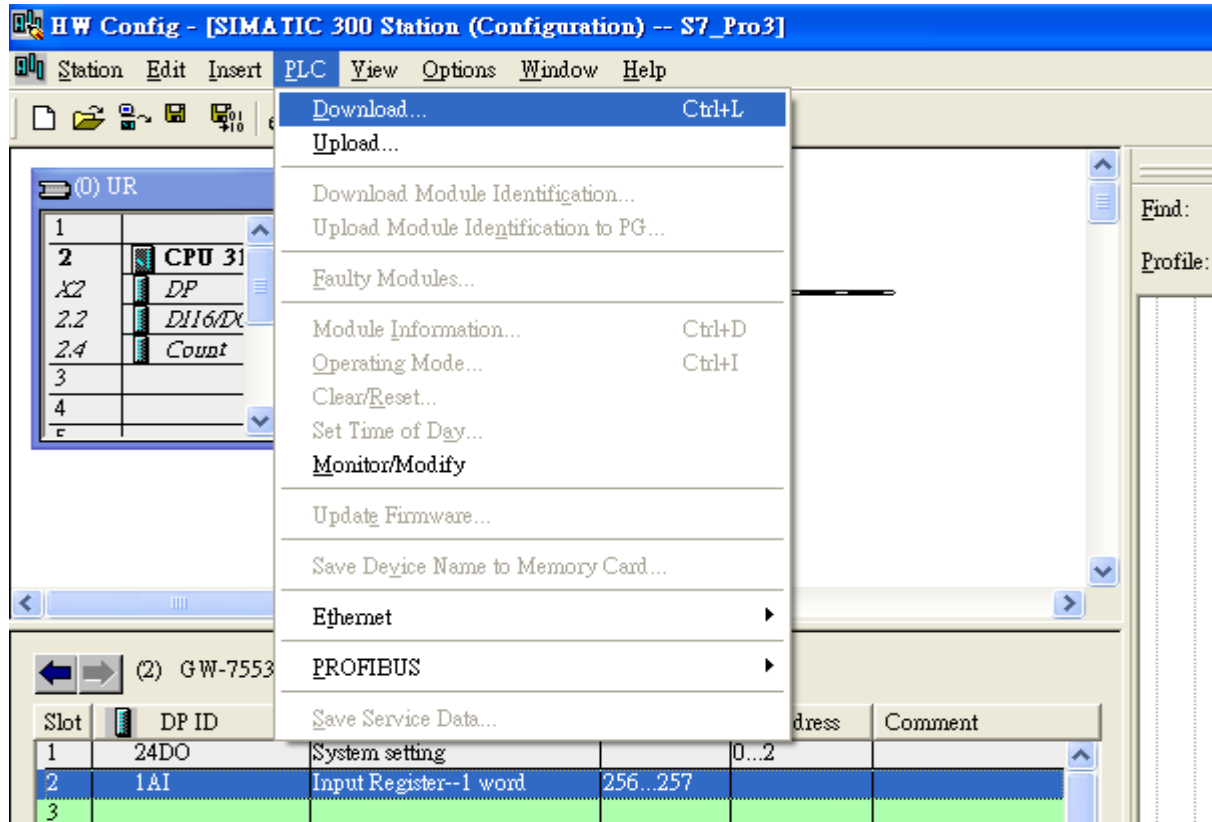

Step 4: Insert a new Organization Block (OB1,OB82,OB86)

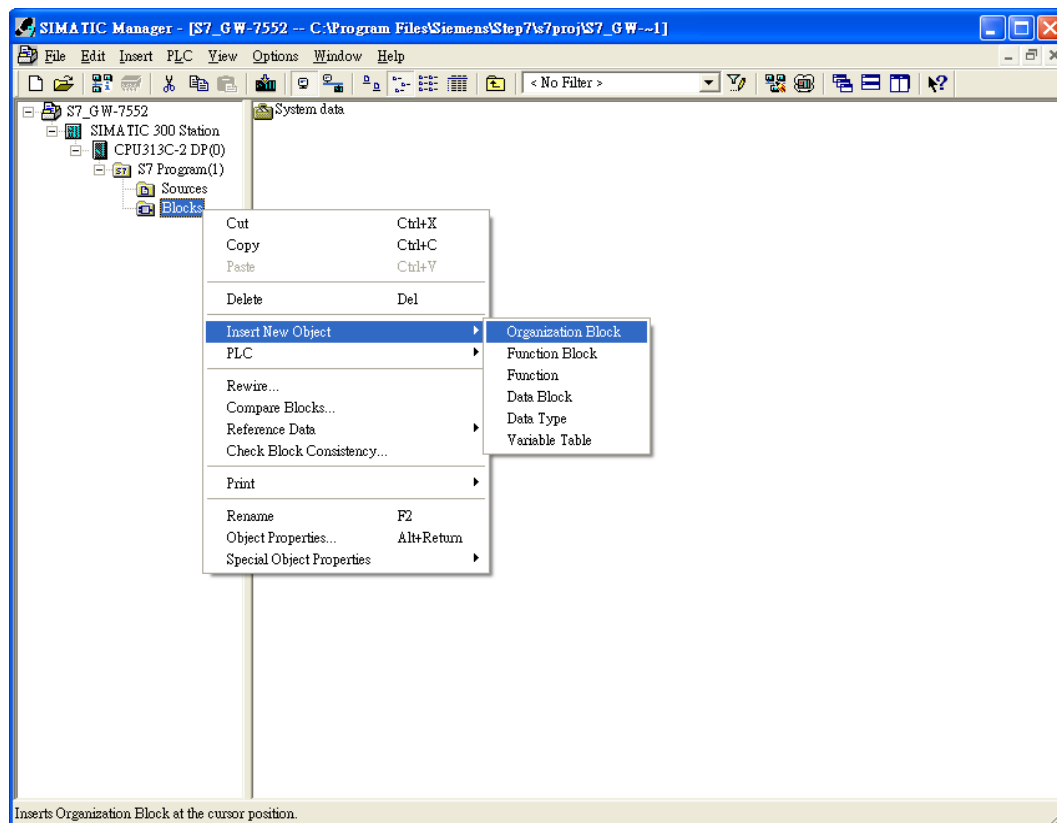

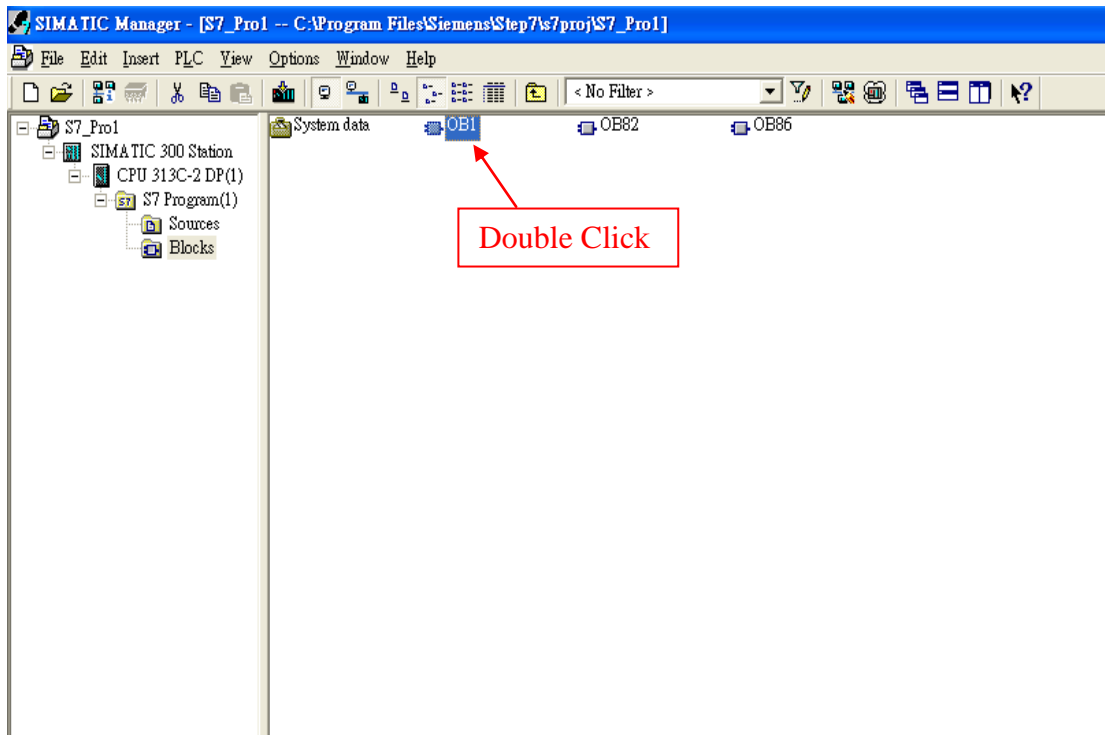
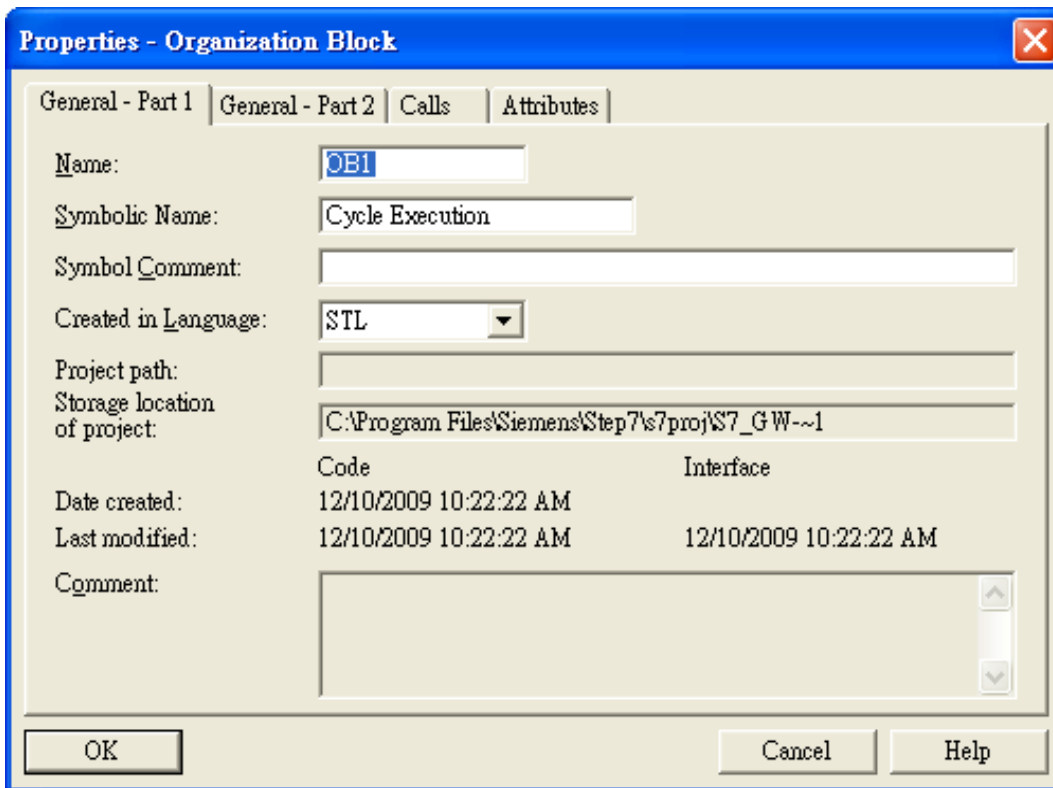

Step 5: Edit OB1

Contents Of: 'Environment\Interface\TEMP'

Name	Data Type	Address
AIValue	Word	20.0
END	Bool	22.0

OB1 : "Main Program Sweep (Cycle)"

Network 1: Read AI

```

    MOVE IN=PIW256, OUT=#AIValue
    END
  
```

Slot	D.	Order Number / Designation	I Address	Q Address	Comment
1	24DC	System setting		0..2	
2	131	Input Register-1 word	256..257		
3					
4					
5					
6					
7					
8					
9					

Step 6: Download the settings into SIMATIC PLC

Download Ctrl+L

- Select Online CPU...
- Establish Connection to Configured CPU
- CPU Messages...
- Display Force Values Ctrl+Alt+F
- Monitor/Modify Variables
- Module Information... Ctrl+D
- Operating Mode... Ctrl+I
- Clear/Reset...
- Set Time of Day...

Contents Of: 'Environment\Interface\TEMP'

Name	Data Type	Address
AIValue	Word	20.0
END	Bool	22.0

Network 1: Read AI

```

    MOVE IN=PIW256, OUT=#AIValue
    END
  
```

Step 7: Make sure the RUN LED of the GW-7553 is on and the switch of the GW-7553 is at Normal mode.



Now the setting procedure has been finished and the user can read the data of the Modbus AI module at address PIW256.

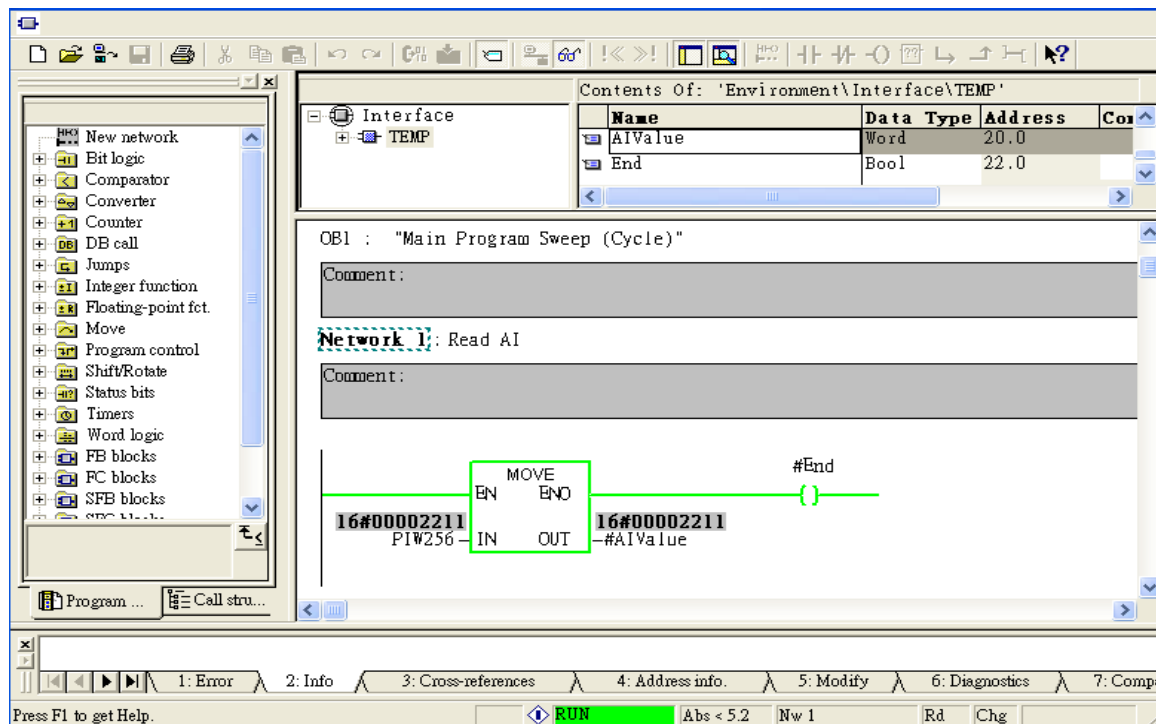

Example 5: PLC writes DO module data to GW-7553.

(Modbus FC05,FC15)

Write a Modbus RTU DO module (**PROFIBUS Slave** & **Modbus RTU/Master**)

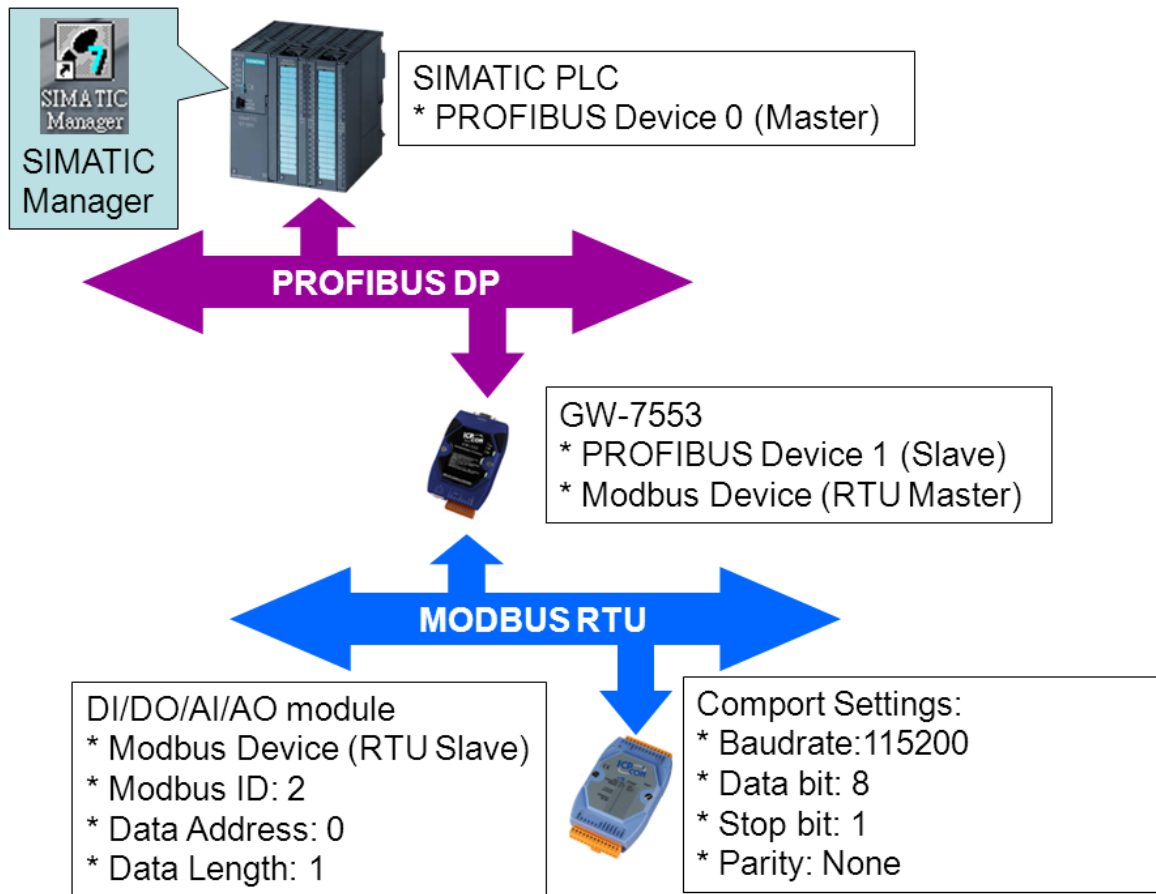

SIMATIC STEP7 Configuration:

Step 1: Setup the GW-7553 module

1. Select GW-7553 module

The screenshot shows the HW Config interface for a SIMATIC 300 station. The rack configuration table is as follows:

Slot	Module
1	CPU 31
2	DP
2.2	DI16/DO
2.4	Count
3	
4	
5	

A red box highlights the GW-7553 module icon in the component palette, with the text "Select GW-7553 module" pointing to it. The table below shows the configuration for the selected module:

Slot	DP ID	Order Number / Designation	I Address	Q Address	Comment
1	24DO	System setting		0...2	
2	8DO	Output Relay/Coil--1 byte		3	
3					

The right-hand side shows the component tree with "GW-7553(DPV1)" selected, and its sub-items expanded.

2. Add a System setting module

The screenshot shows the HW Config interface with the GW-7553 module now installed in slot 2. The rack configuration table is as follows:

Slot	Module
1	CPU 31
2	DP
2.2	DI16/DO
2.4	Count
3	
4	
5	

A red box highlights the "System setting" module in the component tree, with the text "Double click System setting" pointing to it. The table below shows the configuration for the selected module:

Slot	DP ID	Order Number / Designation	I Address	Q Address	Comment
1	24DO	System setting		0...2	
2	8DO	Output Relay/Coil--1 byte		3	
3					

The right-hand side shows the component tree with "System setting" selected under the "GW-7553(DPV1)" module.

3. Add “Onput Relay/Coil—1 byte” module(For FC15,multiple coils, please select more than 1 byte module)

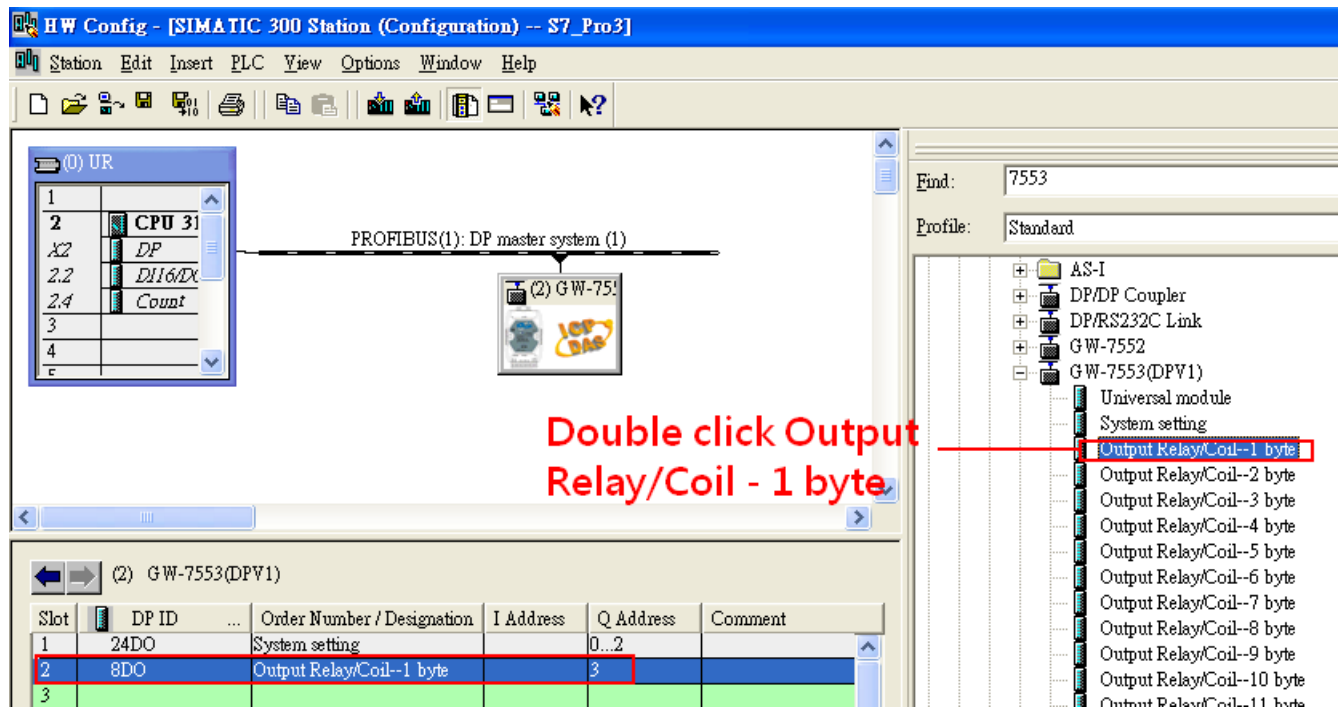

Step 2: Setup the parameters of the GW-7553

1. Double click GW-7553 icon
2. Select “Parameter Assignment”

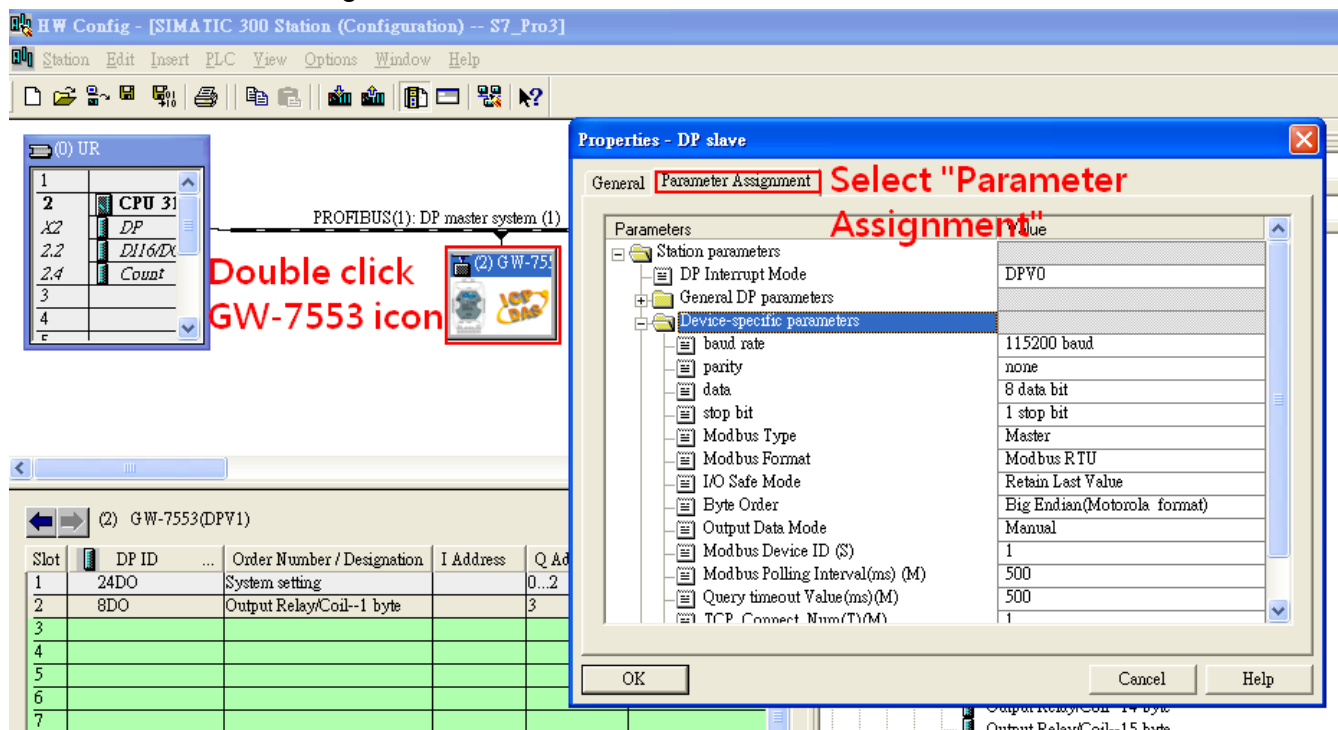

3. Set common parameters of the GW-7553

Common parameters →

Baud rate: 115200; Parity: none; Data: 8 data bit; Stop bit: 1 stop bit; Modbus type: Master

Modbus Format: Modbus RTU; Byte Order: Big Endian

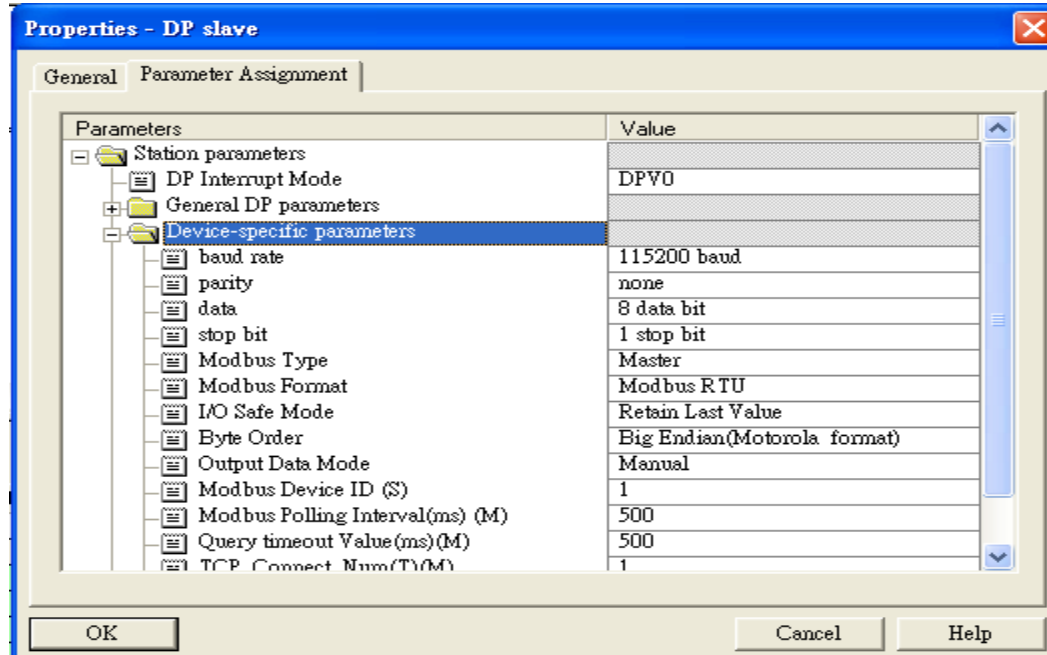

4. Set module parameters of the GW-7553

(1) Double click "Output Relay/Coil—1 byte" module

(2) Select "Parameter Assignment"

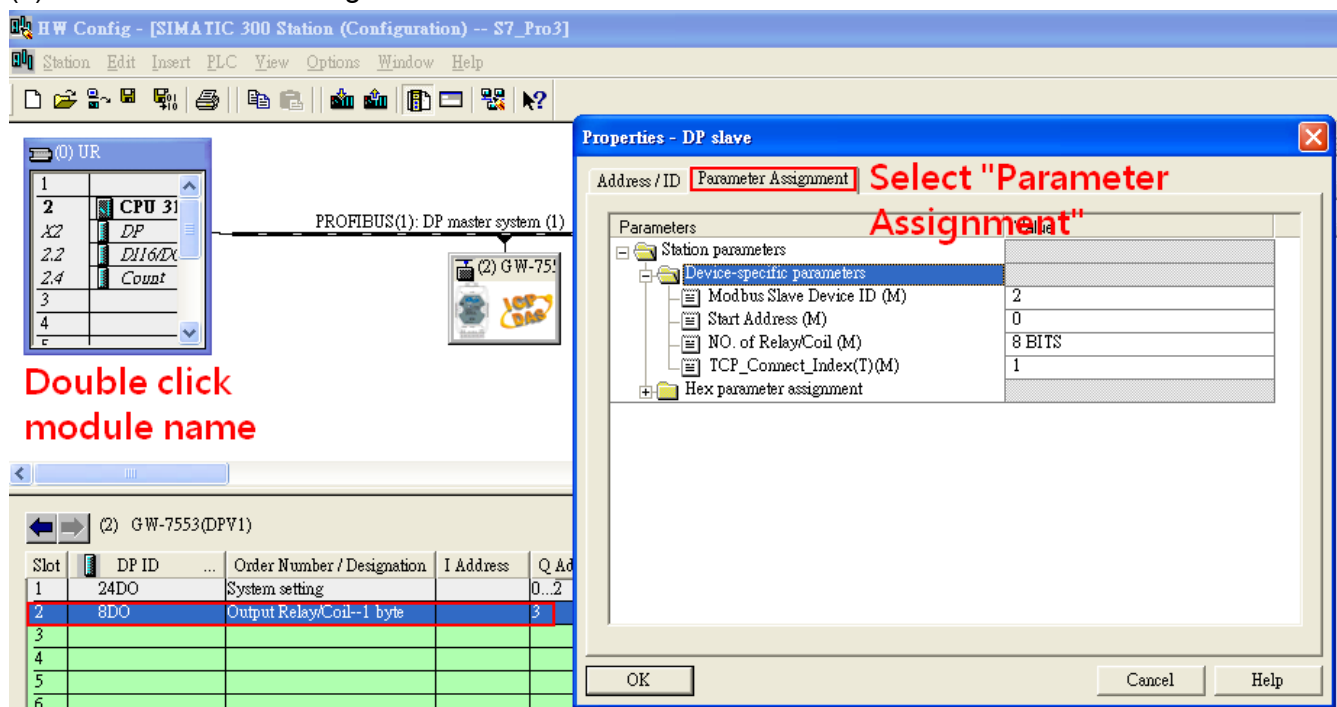

5. Setup "Output Relay/Coil—1 byte" module parameters

Module parameters →

Modbus Slave Device ID: 2; Slave Address: 0 (Protocol address (base 0)), click ok.

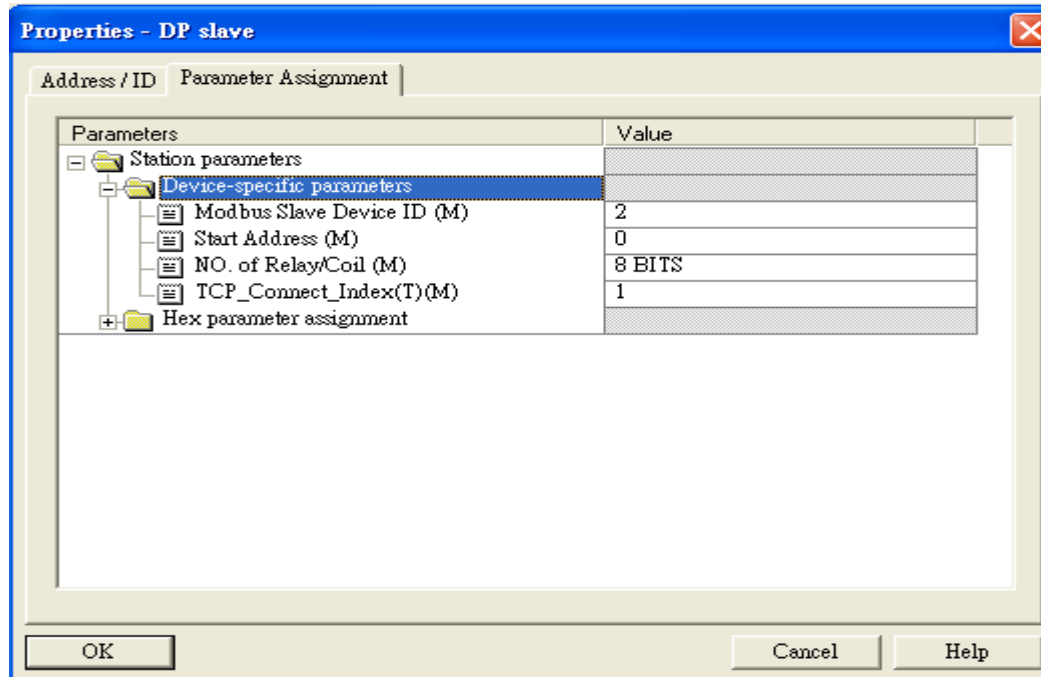

Step 3: Download the HW settings into SIMATIC PLC

1. Save and Compile

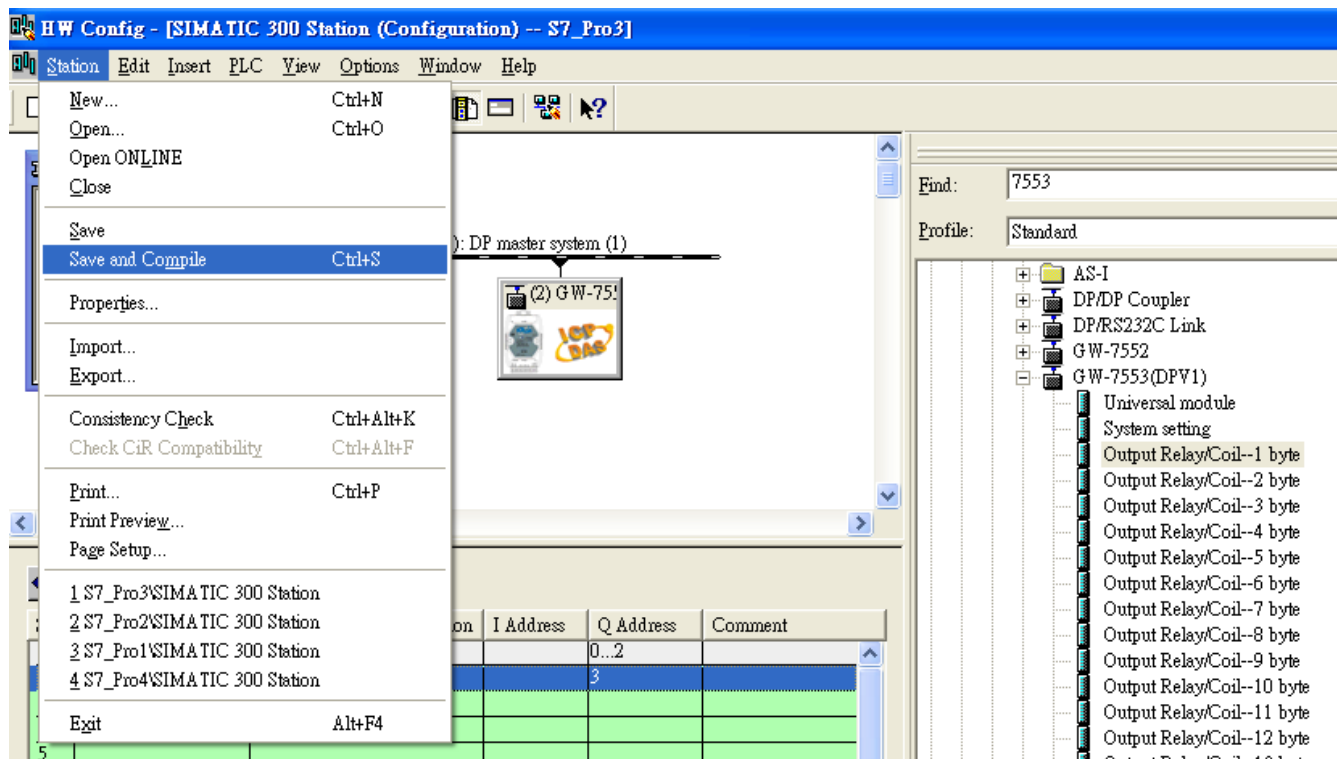

2. HW settings into SIMATIC PLC

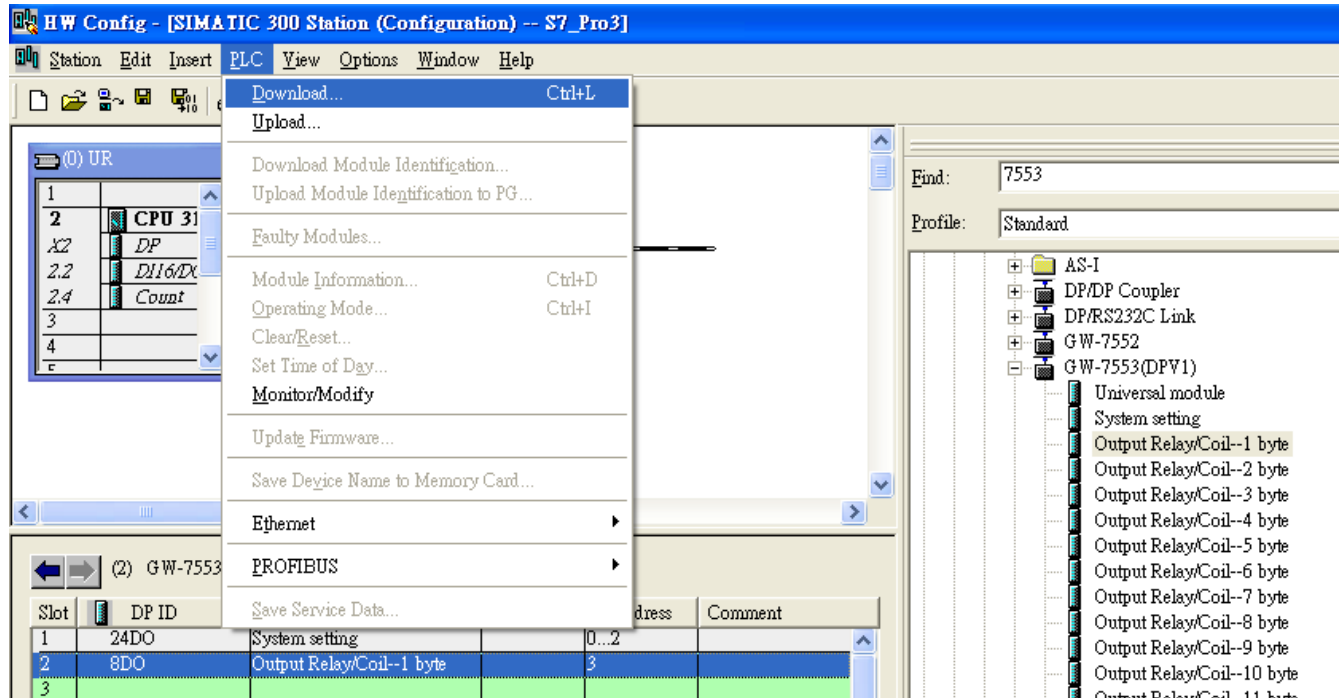

Step 4: Insert a new Organization Block (OB1,OB82,OB86)

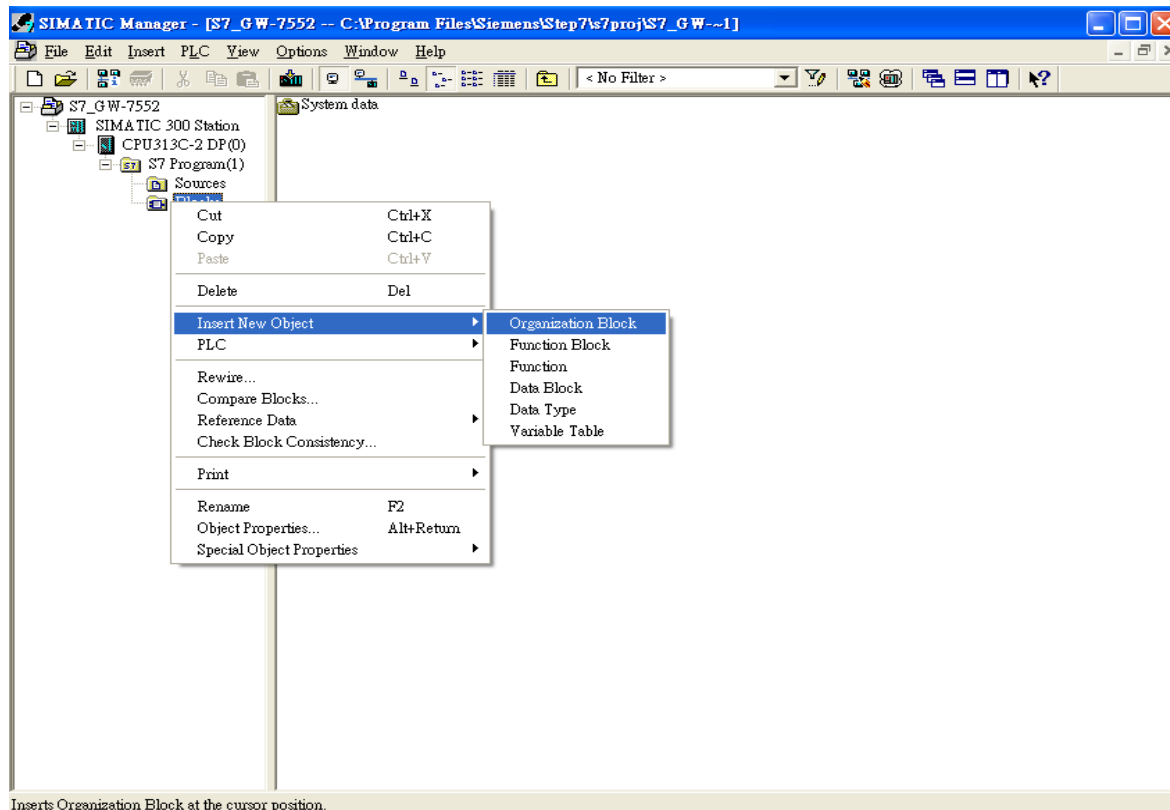

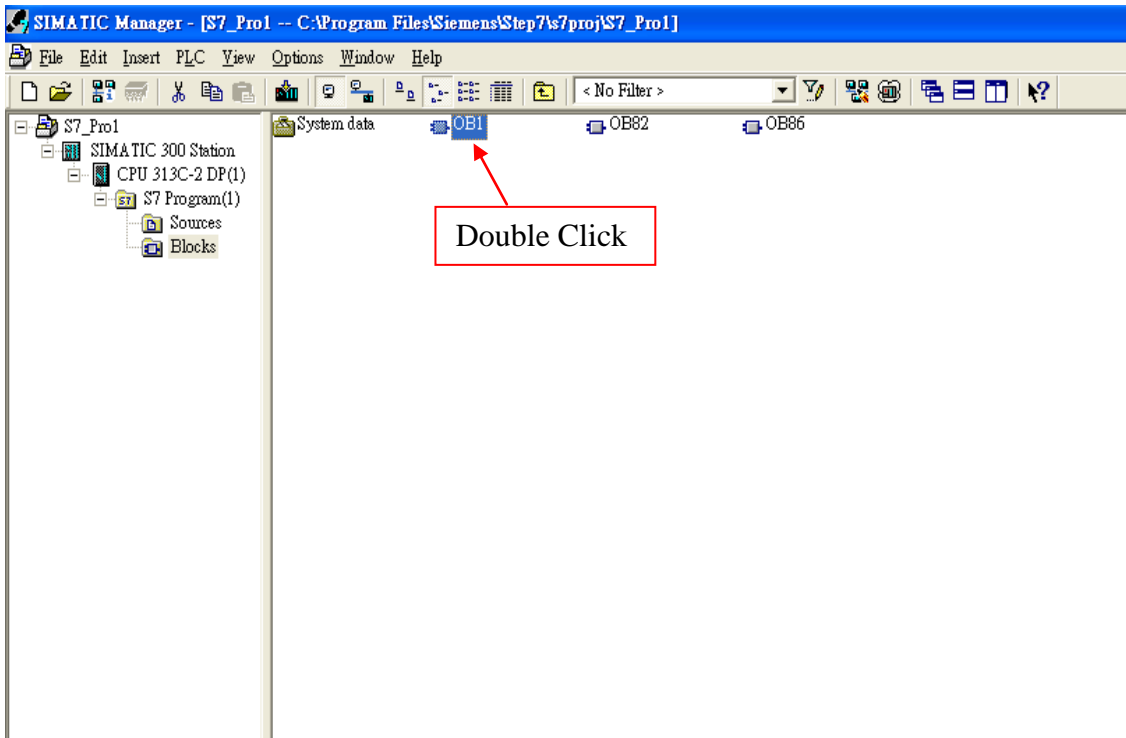
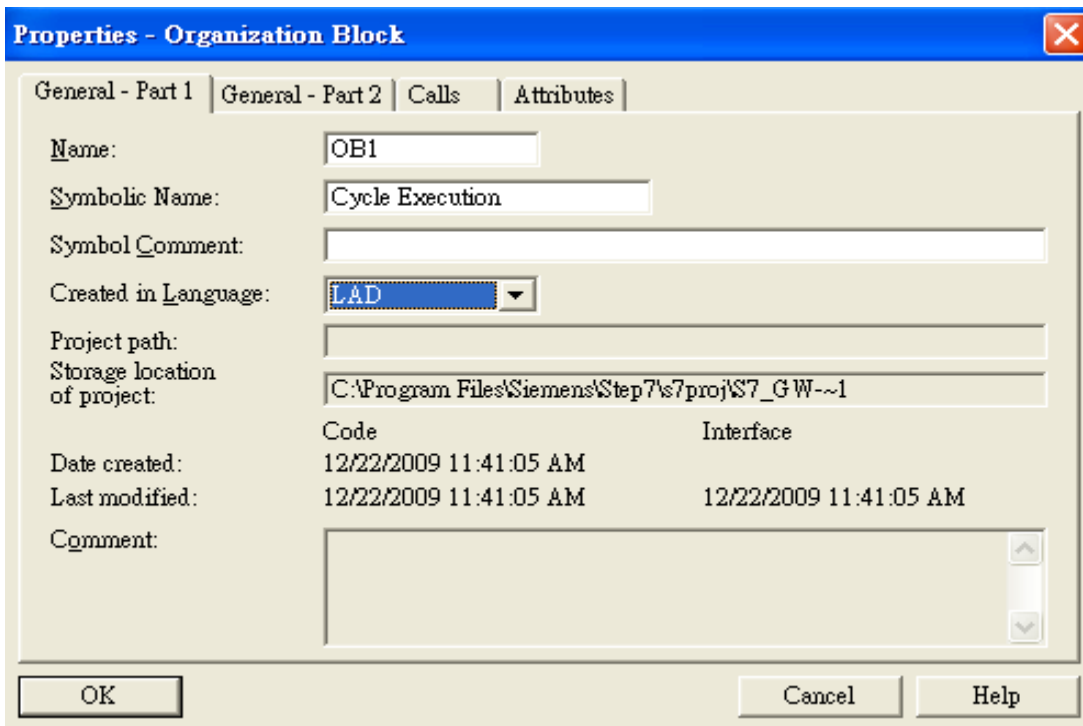

Step 5: Edit OB1

Variables used in the example LD Program:

Name	Data Type	Address	Comment
OB1_DAT...	Date_...	12.0	Date and time OB1 started
END	Bool	20.0	
Init	Bool	20.1	
Tri	Int	22.0	

OB1 : "Main Program Sweep (Cycle)"

Profibus Slave
Modbus Master

Network 1 : Title:

Comment:

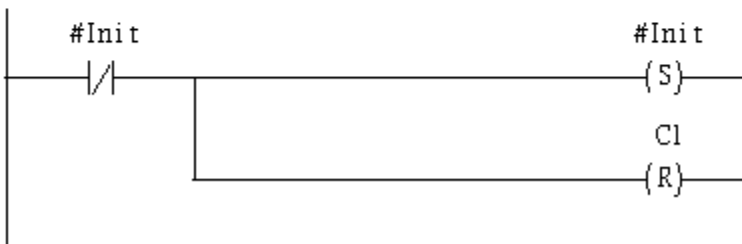

Network 2 : Title:

Comment:

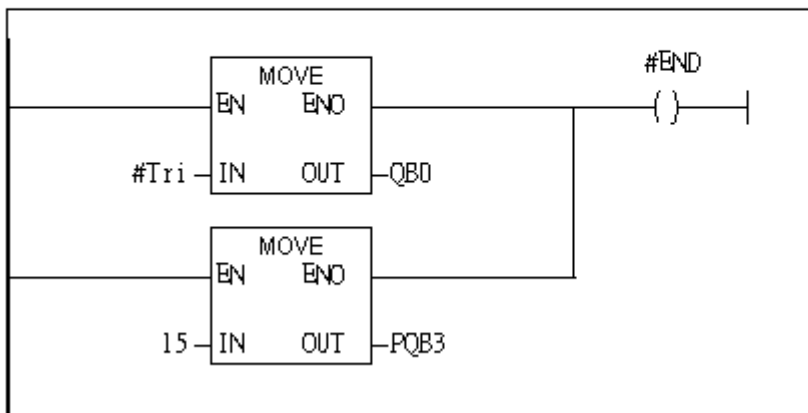

Network 3 : Title:

Comment:

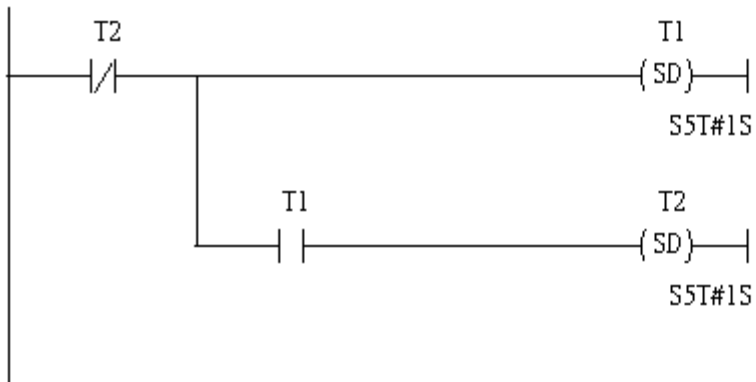

Network 4 : Title:

Comment:

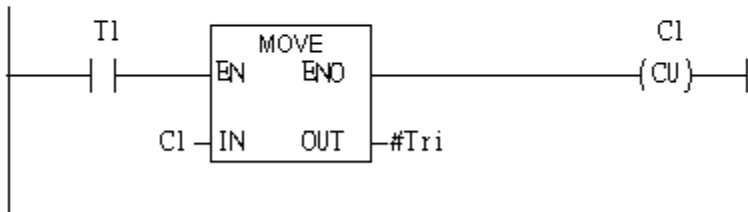

Network 5 : Title:

Comment:

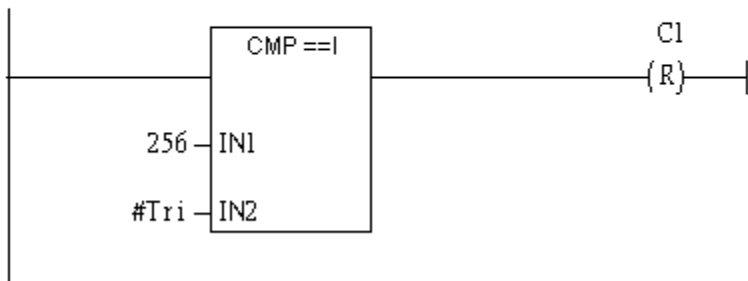

Step 6: Download the settings into SIMATIC PLC

The screenshot shows the SIMATIC Manager interface. The 'Download' menu is open, displaying options such as 'Select Online CPU...', 'Establish Connection to Configured CPU', 'CPU Messages...', 'Display Force Values', 'Monitor/Modify Variables', 'Module Information...', 'Operating Mode...', 'Clear/Reset...', and 'Set Time of Day...'. The main workspace displays a ladder logic network diagram for 'Network 4'. The diagram shows a normally open contact labeled 'T1' connected to the 'EN' input of a 'MOVE' block. The 'CI' input of the 'MOVE' block is also connected to the 'IN' input of a coil labeled '(CU)'. The 'ENO' output of the 'MOVE' block is connected to the 'OUT' output of the coil. A comment field is visible above the diagram.

Name	Data Type	Address	Comment
OBI_MAX...	Int	10.0	Maximum cycle time of OE
OBI_DAT...	Date_...	12.0	Date and time OBI starte
END	Bool	20.0	
Init	Bool	20.1	
Tri	Int	22.0	

Step 7: Make sure the RUN LED of the GW-7553 is on and the switch of the GW-7553 is at Normal mode.



Now the setting procedure has been finished and the user can write the data to the Modbus DO module at address QB3.

Network 2: Title:

Comment:

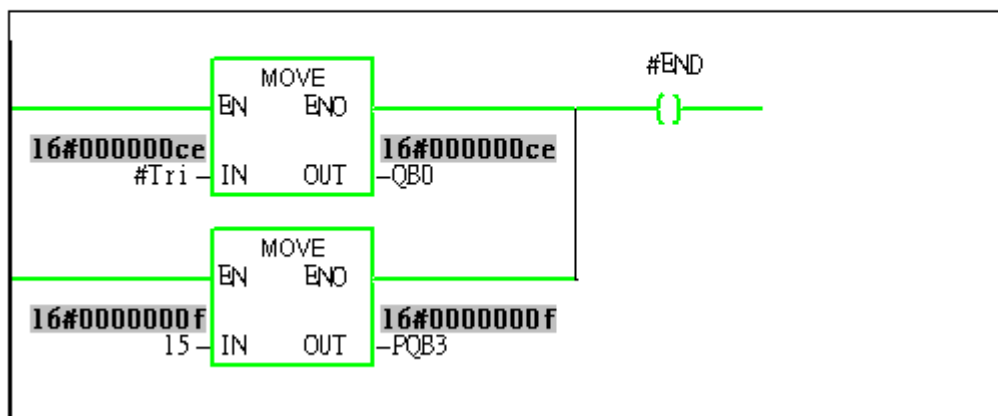

Example 6: PLC writes AO module data to GW-7553.

(Modbus FC06, FC16)

Write a Modbus RTU AO module (**PROFIBUS Slave** & **Modbus RTU/Master**)

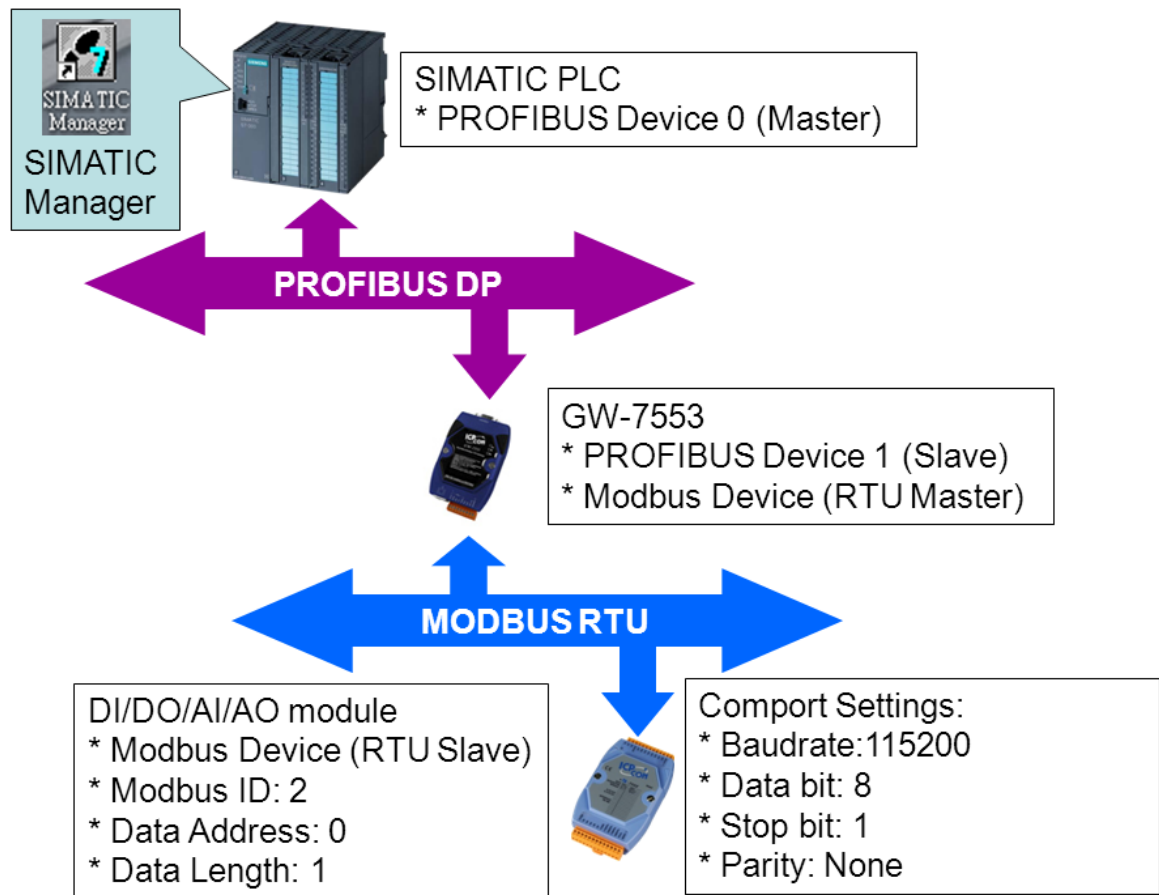

SIMATIC STEP7 Configuration:

Step 1: Setup the GW-7553 module

1. Select GW-7553 module

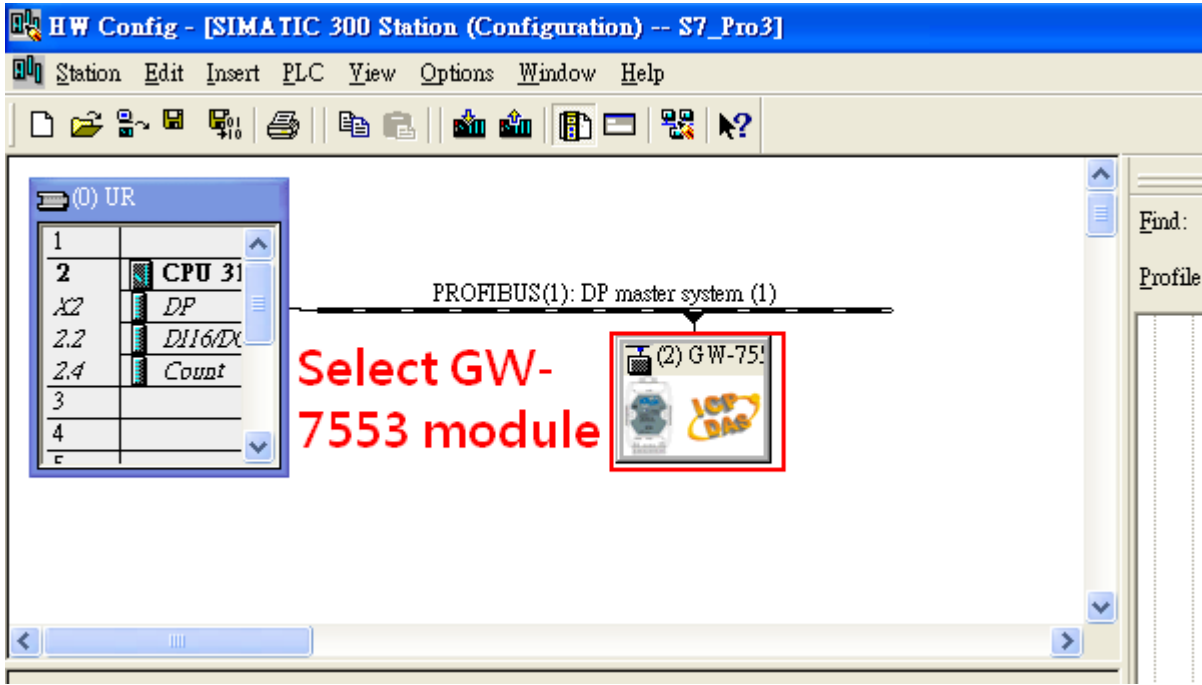

2. Add a System setting module

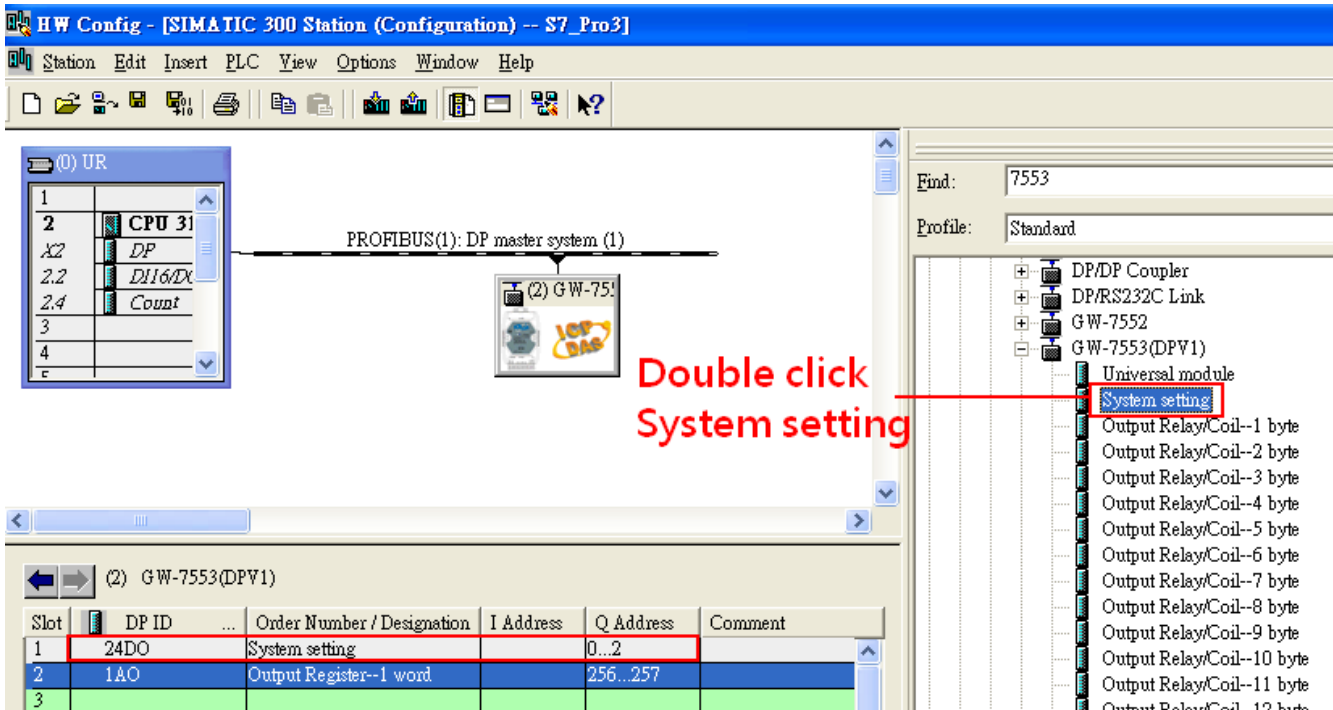

3. Add “Output Register—1word” module(For FC16,multiple registers, please select more than 1 word module)

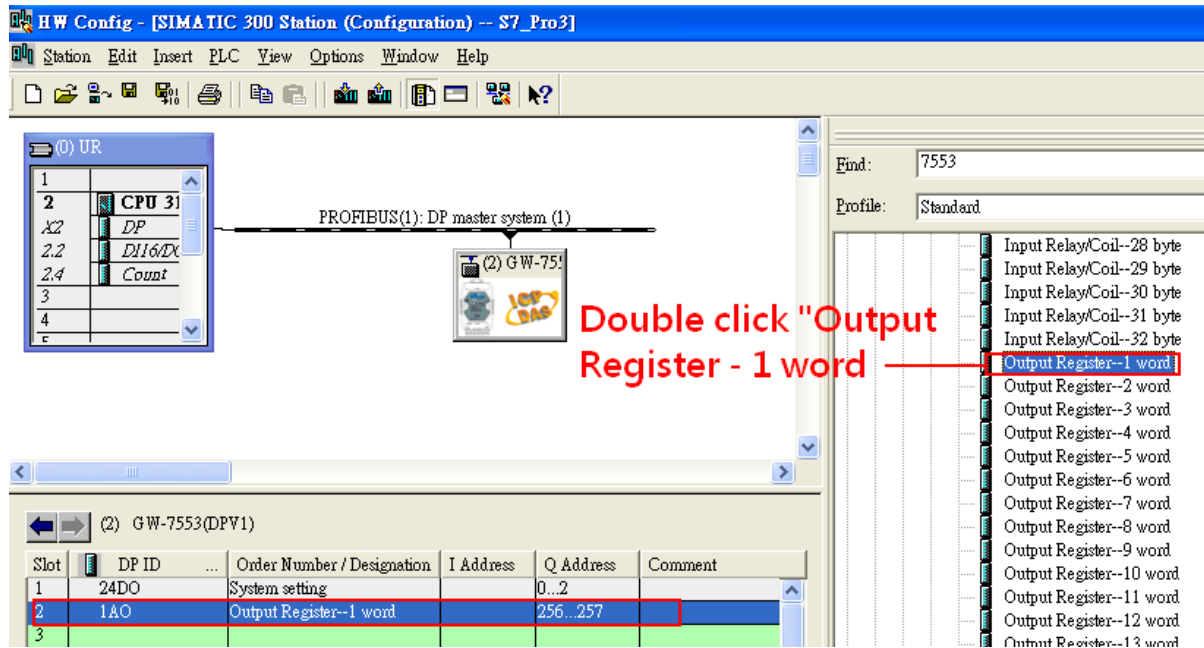

Step 2: Setup the parameters of the GW-7553

1. Double click GW-7553 icon
2. Select “Parameter Assignment”

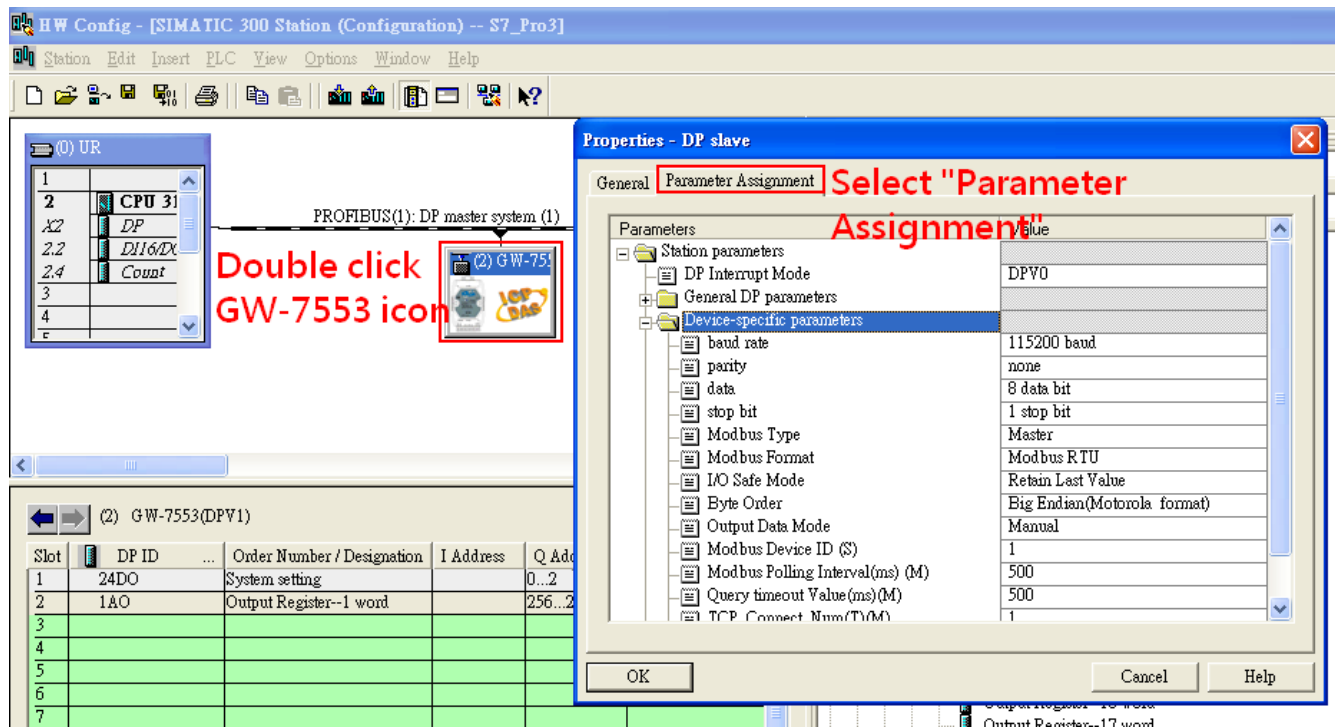

3. Set common parameters of the GW-7553

Common parameters →

Baud rate: 115200; Parity: none; Data: 8 data bit; Stop bit: 1 stop bit; **Modbus type: Master**

Modbus Format: Modbus RTU; Byte Order: Big Endian

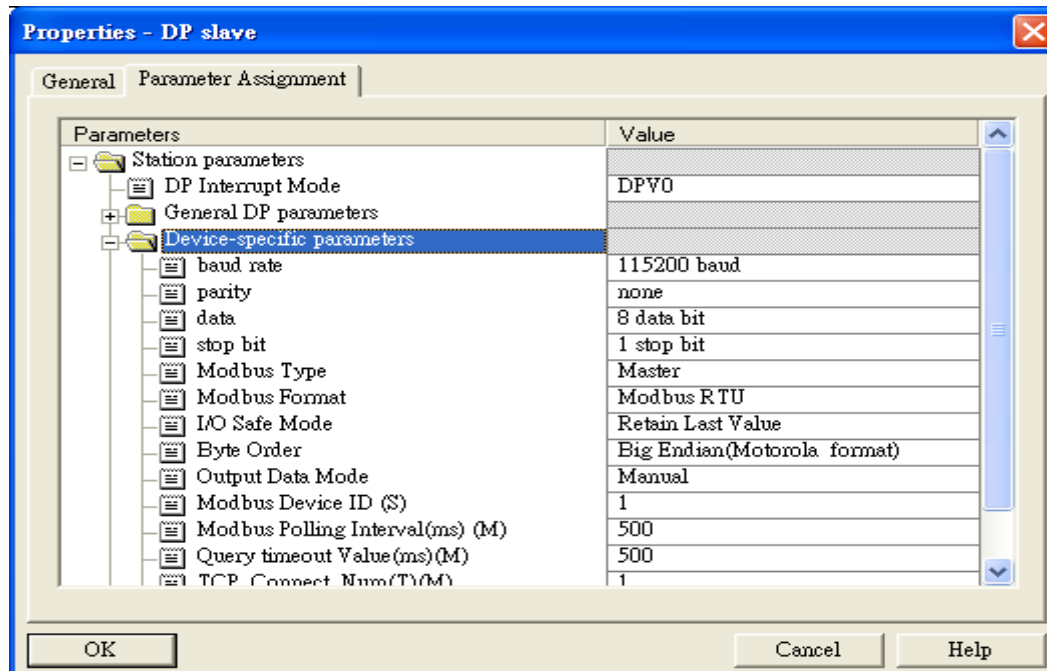

4. Set module parameters of the GW-7553

(1) Double click "Output Register—1 word" module

(2) Select "Parameter Assignment"

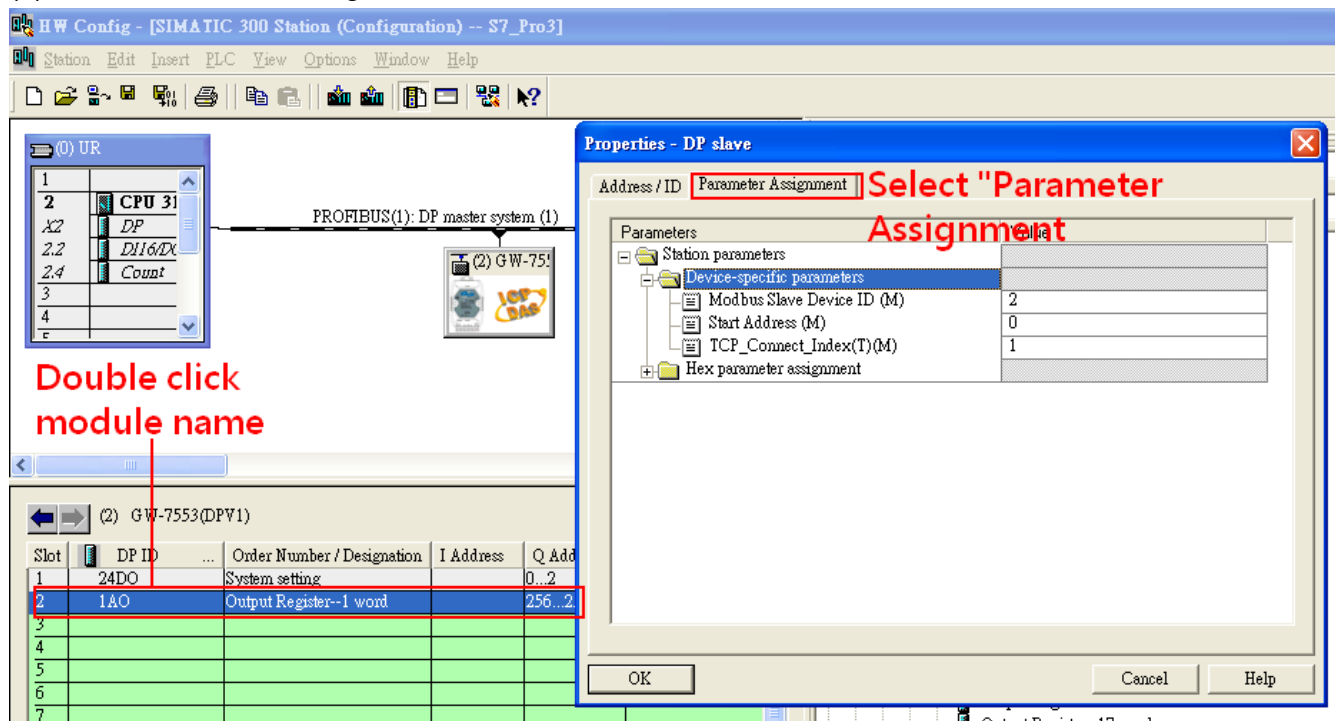

5. Setup "Output Register—1 word" module parameters

Module parameters →

Modbus Slave Device ID: 2; Slave Address: 0 (Protocol address (base 0)), click ok.

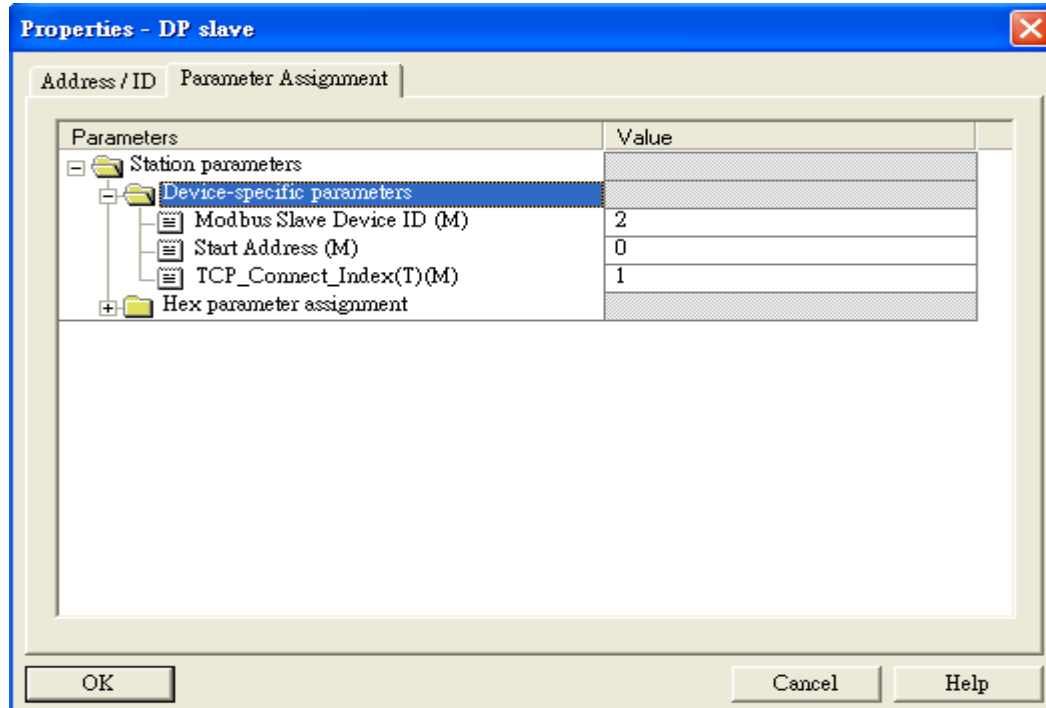

Step 3: Download the HW settings into SIMATIC PLC

1. Save and Compile

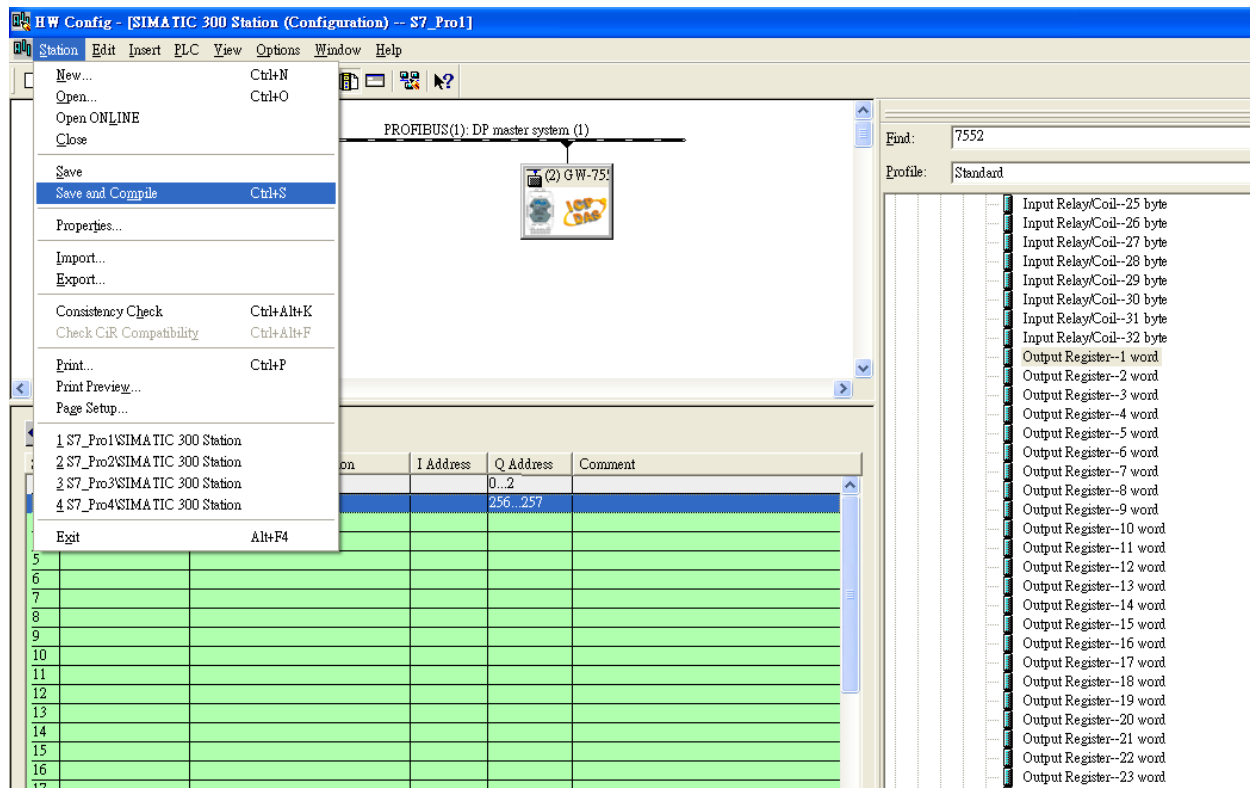

2. HW settings into SIMATIC PLC

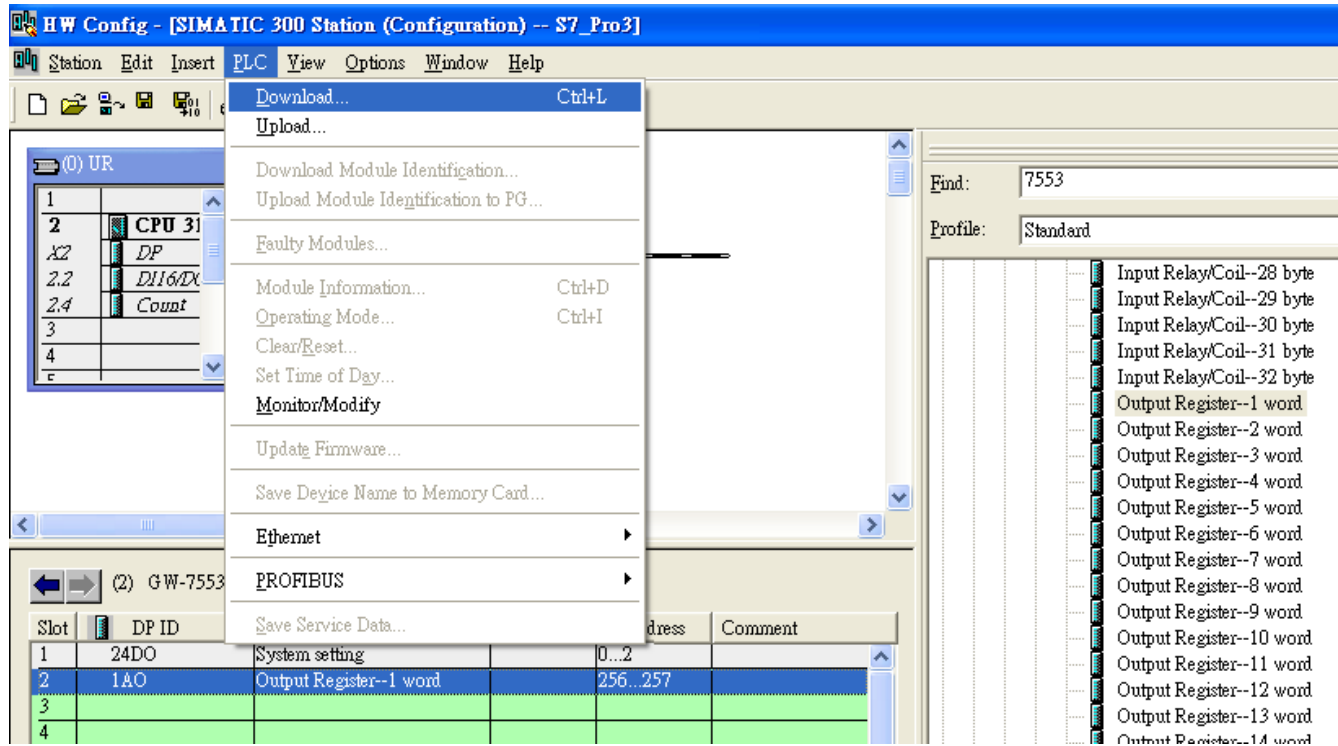

Step 4: Insert a new Organization Block (OB1,OB82,OB86)

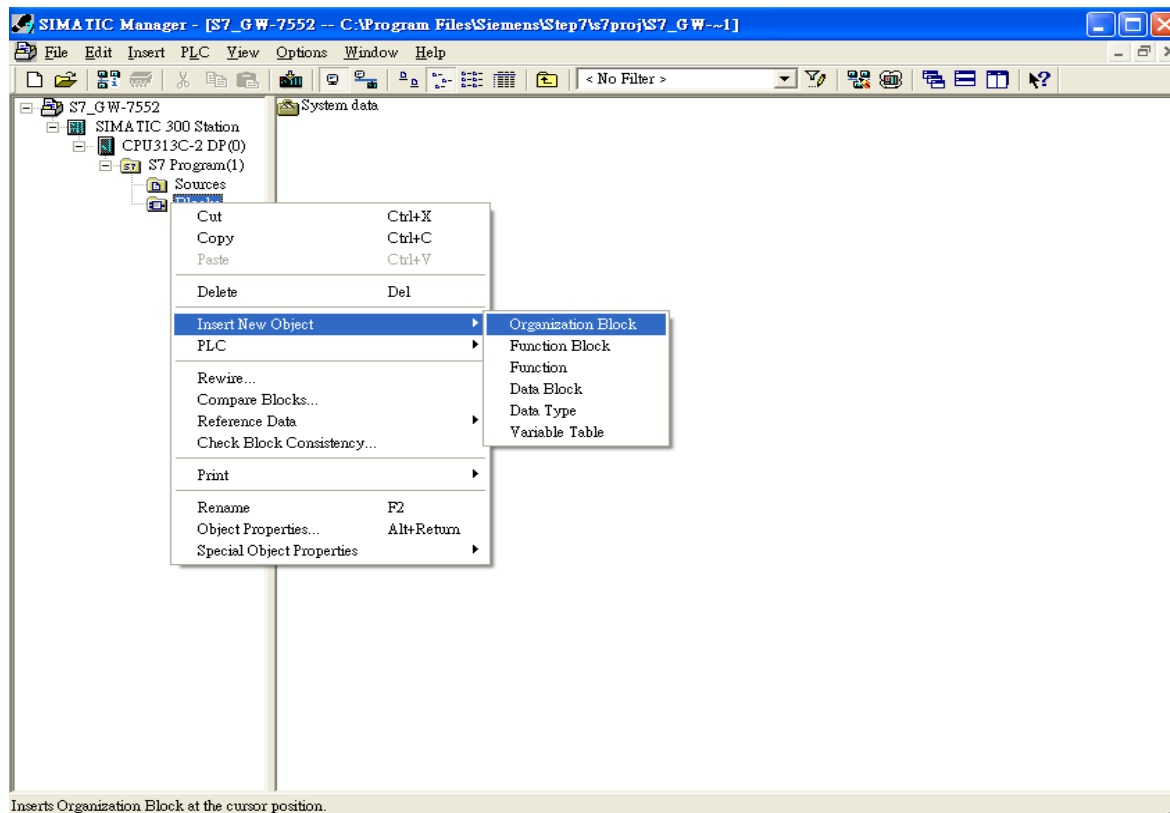

Inserts Organization Block at the cursor position.

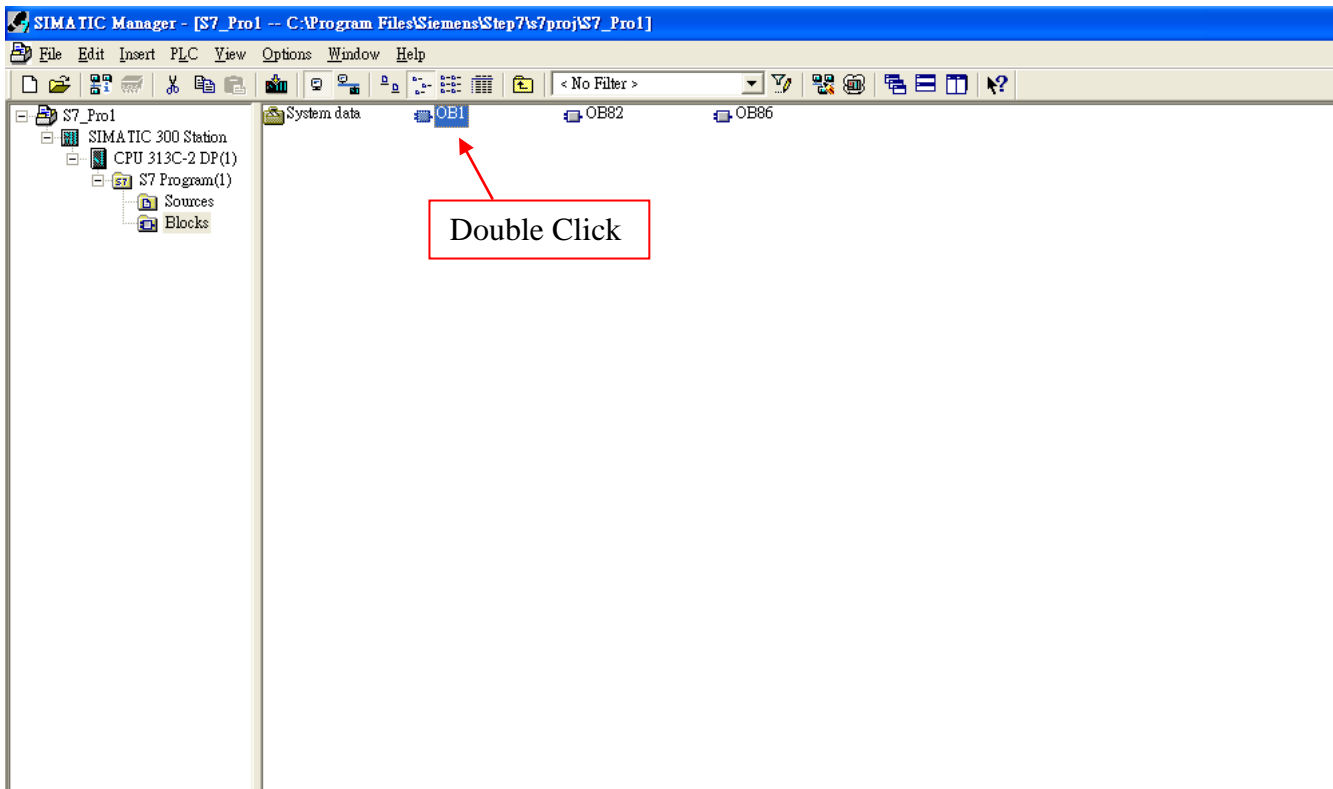
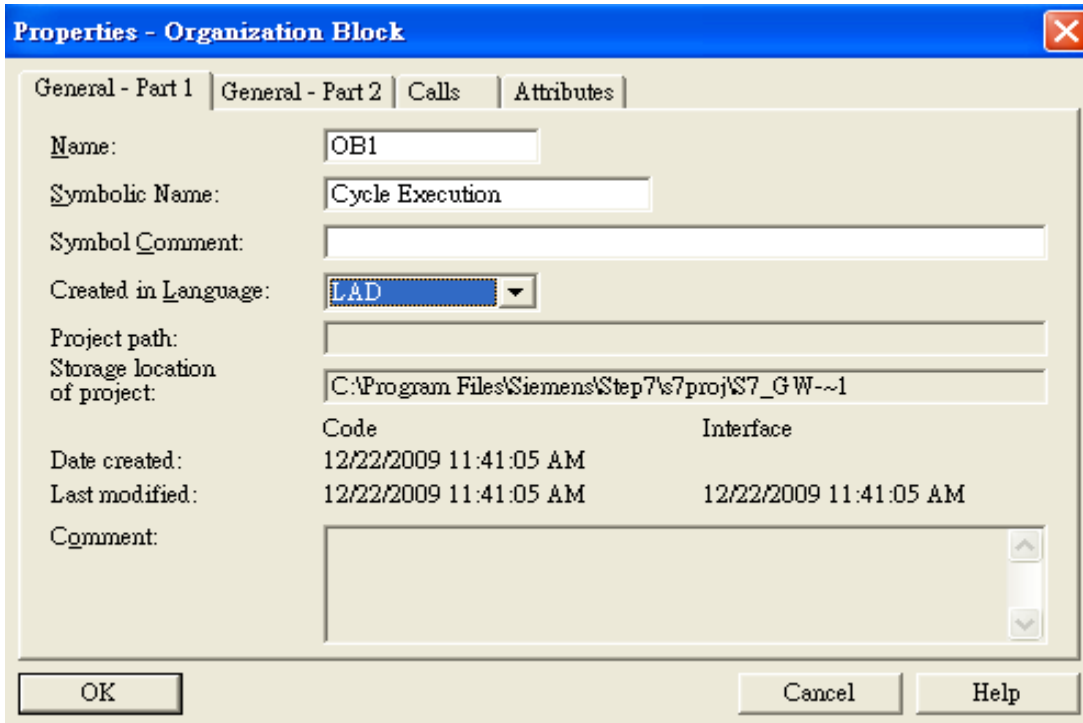

Step 5: Edit OB1

Variables used in the example LD Program:

Name	Data Type	Address	Comment
OB1_MAX...	Int	10.0	Maximum cycle time of OBI (milliseconds)
OB1_DAT...	Date_...	12.0	Date and time OBI started
END	Bool	20.0	
Tri	Int	22.0	
initial	Bool	24.0	

OB1 : "Main Program Sweep (Cycle)"

PROFIBUS Slave
Modbus Master

Network 1 : Reset Counter(C1)

Reset Counter(C1)

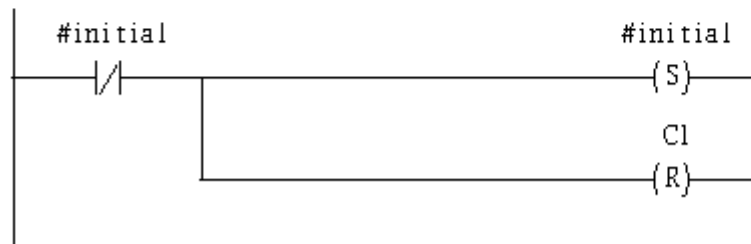

Network 2 : QBO add "1" then PLC will send PQW256 out.

1 word 16AO

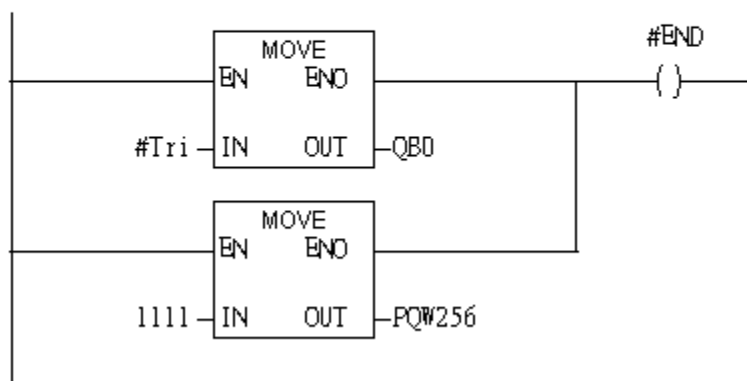

Using T2 trigger T1 If counter (C1) add 1 and Tri will add 1 every 1s.

Network 3 : Timer T1 & T2

Using T2 trigger T1

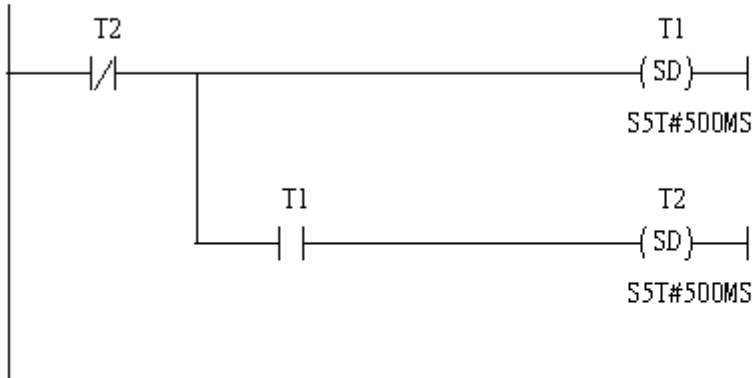

Network 4 : Counter C1

If counter(C1) add "1" and Tri will add "1" ,too.

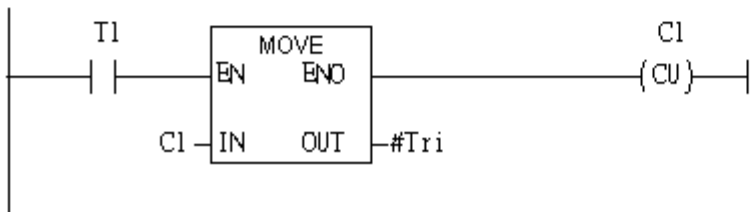

If Tri is equal to 256 then reset counter (C1).

Network 5 : Compare Tri & 256

If Tri is equal to 256 ,C1 will reset.

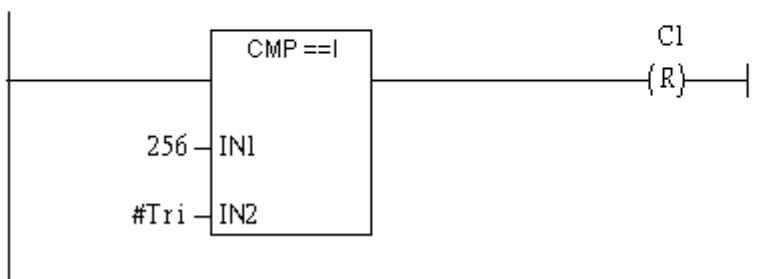

Step 6: Download the settings into SIMATIC PLC

The screenshot shows the SIMATIC Manager interface. The 'Download' menu is open, displaying options such as 'Select Online CPU...', 'Establish Connection to Configured CPU', 'CPU Messages...', 'Display Force Values', 'Monitor/Modify Variables', 'Module Information...', 'Operating Mode...', 'Clear/Reset...', and 'Set Time of Day...'. The 'Operating Mode...' option is highlighted. In the background, a ladder logic diagram is visible, featuring a 'CMP == I' block with inputs 'IN1' (value 256) and 'IN2' (value #Tri). The output of the block is connected to a coil labeled 'C1 (R)'. A table of variables is also visible in the upper right corner.

Name	Data Type	Address	Comment
OBI_PRE...	Int	6.0	Cycle time of previous OBI scan (milliseconds)
OBI_MIN...	Int	8.0	Minimum cycle time of OBI (milliseconds)
OBI_MAX...	Int	10.0	Maximum cycle time of OBI (milliseconds)
OBI_DAT...	Date ...	12.0	Date and time OBI started

Step 7: Make sure the RUN LED of the GW-7553 is on and the switch of the GW-7553 is at Normal mode.



Now the setting procedure has been finished and the user can write the data to the Modbus AO module at address PQW256.

Network 2 : QB0 add "1" then PLC will send PQB256 out.

1 word 16AO

